

powermax1250[®]

Plasma Arc Cutting System

***Operator Manual
803950 Revision 2***

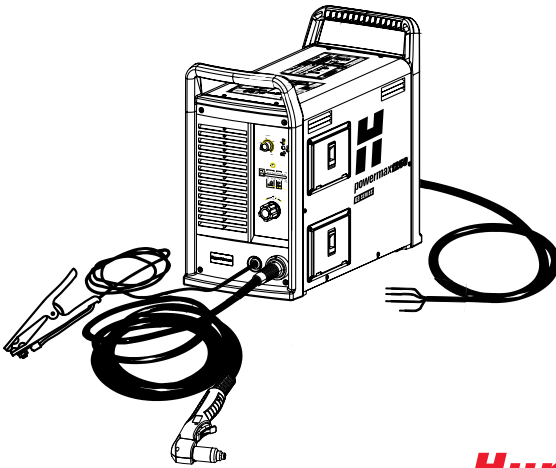

Hypertherm[®]

*The world leader in
plasma cutting technology™*

powermax1250

Operator Manual (P/N 803950)

Revision 2 – November 2013

**Hypertherm, Inc.
Hanover, NH USA
www.hypertherm.com**

© Copyright 2013 Hypertherm, Inc.
All Rights Reserved

Hypertherm, Powermax, and FineCut are trademarks of Hypertherm, Inc.
and may be registered in the United States and/or other countries.

Hypertherm, Inc.

Etna Road, P.O. Box 5010
Hanover, NH 03755 USA
603-643-3441 Tel (Main Office)
603-643-5352 Fax (All Departments)
info@hypertherm.com (Main Office Email)

800-643-9878 Tel (Technical Service)

technical.service@hypertherm.com (Technical Service Email)
800-737-2978 Tel (Customer Service)
customer.service@hypertherm.com (Customer Service Email)

Hypertherm Automation

5 Technology Drive, Suite 300
West Lebanon, NH 03784 USA
603-298-7970 Tel
603-298-7977 Fax

Hypertherm Plasmatechnik GmbH

Technologiepark Hanau
Rodenbacher Chaussee 6
D-63457 Hanau-Wolfgang, Deutschland
49 6181 58 2100 Tel
49 6181 58 2134 Fax

49 6181 58 2123 (Technical Service)**Hypertherm (S) Pte Ltd.**

No. 19 Kaki Bukit Road 2
K.B. Warehouse Complex
Singapore 417847, Republic of Singapore
65 6 841 2489 Tel
65 6 841 2490 Fax

65 6 841 2489 (Technical Service)**Hypertherm (Shanghai) Trading Co., Ltd.**

Unit 1308-09, Careri Building
432 West Huai Hai Road
Shanghai, 200052
PR China
86-21 5258 3330/1 Tel
86-21 5258 3332 Fax

Hypertherm

Branch of Hypertherm, UK, UC
PO Box 244
Wigan, Lancashire, England WN8 7WU
00 800 3324 9737 Tel
00 800 4973 7329 Fax
00 800 4973 7843 (Technical Service)

France (Representative office)

15 Impasse des Rosiers
95610 Eragny, France
00 800 3324 9737 Tel
00 800 4973 7329 Fax

Hypertherm S.r.l.

Via Torino 2
20123 Milano, Italia
39 02 725 46 312 Tel
39 02 725 46 400 Fax
39 02 725 46 314 (Technical Service)

Hypertherm Europe B.V.

Vaartveld 9
4704 SE Roosendaal, Nederland
31 165 596907 Tel
31 165 596901 Fax
31 165 596908 Tel (Marketing)
31 165 596900 Tel (Technical Service)
00 800 49 73 7843 Tel (Technical Serv

Hypertherm Japan Ltd.

801 Samty Will Building
2-40 Miyahara 1-Chome,
Yodogawa-ku, Osaka
532-0003, Japan
81 6 6170 2020 Tel
81 6 6170 2015 Fax

HYPERTHERM BRASIL LTDA.

Avenida Doutor Renato de
Andrade Maia 350
Parque Renato Maia
CEP 07114-000
Guarulhos, SP Brasil
55 11 6409 2636 Tel
55 11 6408 0462 Fax

EMC Introduction

Hypertherm's CE-marked equipment is built in compliance with standard EN60974-10. The equipment should be installed and used in accordance with the information below to achieve electromagnetic compatibility.

The limits required by EN60974-10 may not be adequate to completely eliminate interference when the affected equipment is in close proximity or has a high degree of sensitivity. In such cases it may be necessary to use other measures to further reduce interference.

This plasma equipment is designed for use only in an industrial environment.

Installation and use

The user is responsible for installing and using the plasma equipment according to the manufacturer's instructions. If electromagnetic disturbances are detected then it shall be the responsibility of the user to resolve the situation with the technical assistance of the manufacturer. In some cases this remedial action may be as simple as earthing the cutting circuit, see *Earthing of Workpiece*. In other cases it could involve constructing an electromagnetic screen enclosing the power source and the work complete with associated input filters. In all cases electromagnetic disturbances must be reduced to the point where they are no longer troublesome.

Assessment of area

Before installing the equipment the user shall make an assessment of potential electromagnetic problems in the surrounding area. The following shall be taken into account:

- a. Other supply cables, control cables, signalling and telephone cables; above, below and adjacent to the cutting equipment.
- b. Radio and television transmitters and receivers.
- c. Computer and other control equipment.

- d. Safety critical equipment, for example guarding of industrial equipment.
- e. Health of the people around, for example the use of pacemakers and hearing aids.
- f. Equipment used for calibration or measurement.
- g. Immunity of other equipment in the environment. User shall ensure that other equipment being used in the environment is compatible. This may require additional protection measures.
- h. Time of day that cutting or other activities are to be carried out.

The size of the surrounding area to be considered will depend on the structure of the building and other activities that are taking place. The surrounding area may extend beyond the boundaries of the premises.

Methods of reducing emissions

Mains supply

Cutting equipment must be connected to the mains supply according to the manufacturer's recommendations. If interference occurs, it may be necessary to take additional precautions such as filtering of the mains supply. Consideration should be given to shielding the supply cable of permanently installed cutting equipment, in metallic conduit or equivalent. Shielding should be electrically continuous throughout its length. The shielding should be connected to the cutting mains supply so that good electrical contact is maintained between the conduit and the cutting power source enclosure.

Maintenance of cutting equipment

The cutting equipment must be routinely maintained according to the manufacturer's recommendations. All access and service doors and covers should be closed and properly fastened when the cutting equipment is in operation. The cutting equipment should not be modified in any way except for those changes and adjustments covered in the manufacturer's

ELECTROMAGNETIC COMPATIBILITY (EMC)

instructions. In particular, the spark gaps of arc striking and stabilizing devices should be adjusted and maintained according to the manufacturer's recommendations.

Cutting cables

The cutting cables should be kept as short as possible and should be positioned close together, running at or close to the floor level.

Equipotential bonding

Bonding of all metallic components in the cutting installation and adjacent to it should be considered. However, metallic components bonded to the workpiece will increase the risk that the operator could receive a shock by touching these metallic components and the electrode at the same time. The operator should be insulated from all such bonded metallic components.

Earthing of workpiece

Where the workpiece is not bonded to earth for electrical safety, nor connected to earth because of its size and position, for example, ship's hull or building steelwork, a connection bonding the workpiece to earth may reduce emissions in some, but not all instances. Care should be taken to prevent the earthing of the workpiece increasing the risk of injury to users, or damage to other electrical equipment. Where necessary, the connection of the workpiece to earth should be made by a direct connection to the workpiece, but in some countries where direct connection is not permitted, the bonding should be achieved by suitable capacitances selected according to national regulations.

Note: the cutting circuit may or may not be earthed for safety reasons. Changing the earthing arrangements should only be authorized by a person who is competent to assess whether the changes will increase the risk of injury, for example, by allowing parallel cutting current return paths which may damage the earth circuits of other equipment. Further guidance is given in IEC/ TS 62081 Arc Welding Equipment Installation and Use.

Screening and shielding

Selective screening and shielding of other cables and equipment in the surrounding area may alleviate problems of interference. Screening of the entire plasma cutting installation may be considered for special applications.

Warning

Genuine Hypertherm parts are the factory-recommended replacement parts for your Hypertherm system. Any damage caused by the use of other than genuine Hypertherm parts may not be covered by the Hypertherm warranty.

Warning

You are responsible for the safe use of the Product. Hypertherm does not and cannot make any guarantee or warranty regarding the safe use of the Product in your environment.

General

Hypertherm, Inc. warrants that its Products shall be free from defects in materials and workmanship, if Hypertherm is notified of a defect (i) with respect to the power supply within a period of two (2) years from the date of its delivery to you, with the exception of Powermax Series power supplies, which shall be within a period of three (3) years from the date of delivery to you, and (ii) with respect to the torch and leads within a period of one (1) year from its date of delivery to you. This warranty shall not apply to any Product which has been incorrectly installed, modified, or otherwise damaged. Hypertherm, at its sole option, shall repair, replace, or adjust, free of charge, any defective Products covered by this warranty which shall be returned with Hypertherm's prior authorization (which shall not be unreasonably withheld), properly packed, to Hypertherm's place of business in Hanover, New Hampshire, or to an authorized Hypertherm repair facility, all costs, insurance and freight prepaid. Hypertherm shall not be liable for any repairs, replacement, or adjustments of Products covered by this warranty, except those made pursuant to this paragraph or with Hypertherm's prior written consent. **The warranty above is exclusive and is in lieu of all other warranties, express, implied, statutory, or otherwise with respect to the Products or as to the results which may be obtained therefrom, and all implied warranties or conditions of quality or**

of merchantability or fitness for a particular purpose or against infringement. The foregoing shall constitute the sole and exclusive remedy for any breach by Hypertherm of its warranty. Distributors/OEMs may offer different or additional warranties, but Distributors/OEMs are not authorized to give any additional warranty protection to you or make any representation to you purporting to be binding upon Hypertherm.

Certification test marks

Certified products are identified by one or more certification test marks from accredited testing laboratories. The certification test marks are located on or near the data plate. Each certification test mark means that the product and its safety-critical components conform to the relevant national safety standards as reviewed by that testing laboratory. Hypertherm places a certification test mark on its products only after that product is manufactured with safety-critical components that have been authorized by the accredited testing laboratory.

Once the product has left the Hypertherm factory, the certification test marks are invalidated if any of the following occurs:

- The product is significantly modified in a manner that creates a hazard or non-conformance.
- Safety-critical components are replaced with unauthorized spare parts.
- Any unauthorized assembly or accessory that uses or generates a hazardous voltage is added.
- There is any tampering with a safety circuit or other feature that is designed into the product as part of the certification.

CE marking constitutes a manufacturer's declaration of conformity to applicable European directives and standards. Only those versions of Hypertherm products with a CE Marking located on or near the data plate have been tested for compliance with the European Low Voltage Directive and the European EMC Directive.

WARRANTY

EMC filters needed to comply with the European EMC Directive are incorporated within versions of the power supply with a CE Marking.

Patent indemnity

Except only in cases of products not manufactured by Hypertherm or manufactured by a person other than Hypertherm not in strict conformity with Hypertherm's specifications and in cases of designs, processes, formulae, or combinations not developed or purported to be developed by Hypertherm, Hypertherm will defend or settle, at its own expense, any suit or proceeding brought against you alleging that the use of the Hypertherm product, alone and not in combination with any other product not supplied by Hypertherm, infringes any patent of any third party. You shall notify Hypertherm promptly upon learning of any action or threatened action in connection with any such alleged infringement, and Hypertherm's obligation to indemnify shall be conditioned upon Hypertherm's sole control of, and the indemnified party's cooperation and assistance in, the defense of the claim.

Limitation of liability

In no event shall Hypertherm be liable to any person or entity for any incidental, consequential, indirect, or punitive damages (including but not limited to lost profits) regardless of whether such liability is based on breach of contract, tort, strict liability, breach of warranties, failure of essential purpose or otherwise and even if advised of the possibility of such damages.

Liability cap

In no event shall Hypertherm's liability, whether such liability is based on breach of contract, tort, strict liability, breach of warranties, failure of essential purpose or otherwise, for any claim action suit or proceeding arising out of or relating to the use of the Products exceed in the aggregate the amount paid for the Products that gave rise to such claim.

Insurance

At all times you will have and maintain insurance in such quantities and types, and with coverage sufficient and appropriate to defend and to hold Hypertherm harmless in the event of any cause of action arising from the use of the Products.

National and Local codes

National and Local codes governing plumbing and electrical installation shall take precedent over any instructions contained in this manual. **In no event** shall Hypertherm be liable for injury to persons or property damage by reason of any code violation or poor work practices.

Transfer of rights

You may transfer any remaining rights you may have hereunder only in connection with the sale of all or substantially all of your assets or capital stock to a successor in interest who agrees to be bound by all of the terms and conditions of this Warranty.

Proper disposal of Hypertherm products

Hypertherm plasma cutting systems, like all electronic products, may contain materials or components, such as printed circuit boards, that cannot be discarded with ordinary waste. It is your responsibility to dispose of any Hypertherm product or component part in an environmentally acceptable manner according to national and local codes.

- In the United States, check all federal, state, and local laws.
- In the European Union, check the EU directives, national, and local laws.
- In other countries, check national and local laws.

Register your product on-line at:
www.hypertherm.com/warranty.htm

Electromagnetic Compatibilityi
 Warrantyiii

Section 1 Safety

Recognize safety information1-2
 Follow safety instructions1-2
 Cutting can cause fire or explosion1-2
 Electric shock can kill1-3
 Static electricity can damage circuit boards1-3
 Toxic fumes can cause injury or death1-4
 A plasma arc can cause injury and burns.....1-5
 Arc rays can burn eyes and skin1-5
 Grounding safety1-6
 Compressed gas equipment safety1-6
 Gas cylinders can explode if damaged1-6
 Noise can damage hearing1-7
 Pacemaker and hearing aid operation1-7
 A plasma arc can damage frozen pipes1-7
 Additional safety information1-7
 Warning label.....1-8

Section 1a Sécurité

Identifier les consignes de sécurité1a-2
 Suivre les instructions de sécurité1a-2
 Danger Avertissement Précaution1a-2
 Le coupage peut provoquer un incendie ou une explosion1a-2
 Les chocs électriques peuvent être fatals1a-3
 L'électricité statique peut endommager les cartes de circuits imprimés.....1a-3
 Le vapeurs toxiques peuvent provoquer des blessures ou la mort1a-4
 L'arc plasma peut provoquer des blessures ou des brûlures1a-5
 Les rayons de l'arc peuvent brûler les yeux et la peau1a-5
 Mise à la masse et à la terre1a-6
 Sécurité des bouteilles de gaz comprimé1a-6
 Les bouteilles de gaz comprimé peuvent exploser en cas de dommages1a-6
 Le bruit peut provoquer des problèmes auditifs1a-7
 Pacemakers et prothèses auditives1a-7
 Un arc plasma peut endommager les tuyaux gelés1a-7
 Étiquette de sécurité.....1a-8

Section 1b Seguridad

Reconocimiento de información de seguridad1b-2
 Siga las instrucciones de seguridad1b-2
 Los cortes pueden provocar incendios o explosiones1b-2
 El choque eléctrico puede provocar la muerte1b-3
 Electricidad estática puede dañar tablillas de circuito1b-3
 Humos tóxicos pueden causar lesiones o muerte1b-4
 El arco de plasma puede causar lesiones y quemaduras1b-5
 Los rayos del arco pueden producir quemaduras en los ojos y en la piel.....1b-5

TABLE OF CONTENTS

Seguridad de toma a tierra	1b-6
Seguridad de los equipos de gas comprimido	1b-6
Los cilindros de gas pueden explotar si están dañados.....	1b-6
El ruido puede deteriorar la audición.....	1b-7
Operación de marcapasos y de audífonos.....	1b-7
Un arco plasma puede dañar tubos congelados.....	1b-7
Etiquetas de advertencia.....	1b-8

Section 2 Specifications

Power supply	2-2
Dimensions and weight.....	2-3
T80 Torches	2-4
Dimensions	2-5
Symbols and markings.....	2-6
[S] mark	2-6
CE mark.....	2-6
IEC symbols used.....	2-6

Section 3 Setup

Upon receipt.....	3-2
Claims	3-2
Contents of box	3-2
Locating the power supply.....	3-3
Lifting the power supply.....	3-3
Power connection.....	3-4
Three-phase power cord – plug installation	3-4
Single-phase power cord.....	3-5
Power cord installation.....	3-5
Plug installation.....	3-5
Grounding	3-6
Extension cords.....	3-6
Torch installation.....	3-7
Plasma gas supply	3-9
Additional gas filtration.....	3-9
Gas supply installation	3-10
T80M torch alignment.....	3-10
ON/OFF pendant connection	3-11
Machine interface connection	3-11
Arc voltage.....	3-12
Changing XFER (start machine motion) from dry contact closure to voltage signal.....	3-14
Driving an industrial isolated input module	3-15
Driving a relay coil with an external power source.....	3-16
Driving an industrial isolated input module with an external power source	3-17

Section 4 Operation

Controls and indicators.....4-3
 Indicator LEDs4-3
 T80 consumable configurations4-4
 Shielded.....4-4
 FineCut4-4
 Gouging4-5
 T80M consumable configurations4-5
 Shielded.....4-5
 FineCut4-6
 Ohmic sensing retaining cap4-6
 Unshielded.....4-6
 Install the torch consumables4-7
 Set the mode switch4-8
 Set the power switch to ON4-8
 Check the indicator lights4-8
 Adjust the gas pressure and current setting4-9
 Hand torch operation.....4-10
 Safety trigger operation4-10
 Attach the work clamp.....4-11
 Starting a cut from the edge of the workpiece4-11
 Hand torch cutting technique4-12
 Piercing.....4-13
 Gouging4-14
 Cut charts4-15
 80 amp mechanized shielded consumables.....4-15
 60 amp mechanized shielded consumables.....4-16
 40 amp mechanized shielded consumables.....4-17
 FineCut consumables4-18
 40 amp mechanized unshielded consumables.....4-19

Section 5 Maintenance and Parts

Routine maintenance5-2
 Inspect the consumables.....5-3
 Controls and indicators.....5-4
 Indicator LEDs5-4
 Basic troubleshooting5-5
 System circuit diagram5-8
 Technical questions5-9
 Parts.....5-9
 Torch parts5-9
 Power supply parts5-10
 Accessories5-10

TABLE OF CONTENTS

Section 1

SAFETY

In this section:

Recognize safety information	1-2
Follow safety instructions	1-2
Cutting can cause fire or explosion	1-2
Electric shock can kill	1-3
Static electricity can damage circuit boards	1-3
Toxic fumes can cause injury or death	1-4
A plasma arc can cause injury and burns.....	1-5
Arc rays can burn eyes and skin	1-5
Grounding safety	1-6
Compressed gas equipment safety	1-6
Gas cylinders can explode if damaged	1-6
Noise can damage hearing	1-7
Pacemaker and hearing aid operation	1-7
A plasma arc can damage frozen pipes	1-7
Additional safety information	1-7
Warning labels.....	1-8



RECOGNIZE SAFETY INFORMATION

The symbols shown in this section are used to identify potential hazards. When you see a safety symbol in this manual or on your machine, understand the potential for personal injury, and follow the related instructions to avoid the hazard.



FOLLOW SAFETY INSTRUCTIONS

Read carefully all safety messages in this manual and safety labels on your machine.

- Keep the safety labels on your machine in good condition. Replace missing or damaged labels immediately.
- Learn how to operate the machine and how to use the controls properly. Do not let anyone operate it without instruction.

- Keep your machine in proper working condition. Unauthorized modifications to the machine may affect safety and machine service life.

DANGER WARNING CAUTION

A signal word DANGER or WARNING is used with a safety symbol. DANGER identifies the most serious hazards.

- DANGER and WARNING safety labels are located on your machine near specific hazards.
- WARNING safety messages precede related instructions in this manual that may result in injury or death if not followed correctly.
- CAUTION safety messages precede related instructions in this manual that may result in damage to equipment if not followed correctly.



CUTTING CAN CAUSE FIRE OR EXPLOSION

Fire Prevention

- Be sure the area is safe before doing any cutting. Keep a fire extinguisher nearby.
- Remove all flammables within 35 feet (10 m) of the cutting area.
- Quench hot metal or allow it to cool before handling or before letting it touch combustible materials.
- Never cut containers with potentially flammable materials inside – they must be emptied and properly cleaned first.
- Ventilate potentially flammable atmospheres before cutting.
- When cutting with oxygen as the plasma gas, an exhaust ventilation system is required.

Explosion Prevention

- Do not use the plasma system if explosive dust or vapors may be present.
- Do not cut pressurized cylinders, pipes, or any closed container.
- Do not cut containers that have held combustible materials.



WARNING

Explosion Hazard

Argon-Hydrogen and Methane

Hydrogen and methane are flammable gases that present an explosion hazard. Keep flames away from cylinders and hoses that contain methane or hydrogen mixtures. Keep flames and sparks away from the torch when using methane or argon-hydrogen plasma.



WARNING

Hydrogen Detonation with Aluminum Cutting

- When cutting aluminum underwater, or with the water touching the underside of the aluminum, free hydrogen gas may collect under the workpiece and detonate during plasma cutting operations.
- Install an aeration manifold on the floor of the water table to eliminate the possibility of hydrogen detonation. Refer to the Appendix section of this manual for aeration manifold details.



ELECTRIC SHOCK CAN KILL

Touching live electrical parts can cause a fatal shock or severe burn.

- Operating the plasma system completes an electrical circuit between the torch and the workpiece. The workpiece and anything touching the workpiece are part of the electrical circuit.
- Never touch the torch body, workpiece or the water in a water table when the plasma system is operating.

Electric Shock Prevention

All Hypertherm plasma systems use high voltage in the cutting process (200 to 400 VDC are common). Take the following precautions when operating this system:

- Wear insulated gloves and boots, and keep your body and clothing dry.
- Do not stand, sit or lie on – or touch – any wet surface when using the plasma system.
- Insulate yourself from work and ground using dry insulating mats or covers big enough to prevent any physical contact with the work or ground. If you must work in or near a damp area, use extreme caution.
- Provide a disconnect switch close to the power supply with properly sized fuses. This switch allows the operator to turn off the power supply quickly in an emergency situation.
- When using a water table, be sure that it is correctly connected to earth ground.

- Install and ground this equipment according to the instruction manual and in accordance with national and local codes.
- Inspect the input power cord frequently for damage or cracking of the cover. Replace a damaged power cord immediately. **Bare wiring can kill.**
- Inspect and replace any worn or damaged torch leads.
- Do not pick up the workpiece, including the waste cutoff, while you cut. Leave the workpiece in place or on the workbench with the work cable attached during the cutting process.
- Before checking, cleaning or changing torch parts, disconnect the main power or unplug the power supply.
- Never bypass or shortcut the safety interlocks.
- Before removing any power supply or system enclosure cover, disconnect electrical input power. Wait 5 minutes after disconnecting the main power to allow capacitors to discharge.
- Never operate the plasma system unless the power supply covers are in place. Exposed power supply connections present a severe electrical hazard.
- When making input connections, attach proper grounding conductor first.
- Each Hypertherm plasma system is designed to be used only with specific Hypertherm torches. Do not substitute other torches which could overheat and present a safety hazard.



STATIC ELECTRICITY CAN DAMAGE CIRCUIT BOARDS

Use proper precautions when handling printed circuit boards.

- Store PC boards in anti-static containers.
- Wear a grounded wrist strap when handling PC boards.



TOXIC FUMES CAN CAUSE INJURY OR DEATH

The plasma arc by itself is the heat source used for cutting. Accordingly, although the plasma arc has not been identified as a source of toxic fumes, the material being cut can be a source of toxic fumes or gases that deplete oxygen.

Fumes produced vary depending on the metal that is cut. Metals that may release toxic fumes include, but are not limited to, stainless steel, carbon steel, zinc (galvanized), and copper.

In some cases, the metal may be coated with a substance that could release toxic fumes. Toxic coatings include, but are not limited to, lead (in some paints), cadmium (in some paints and fillers), and beryllium.

Gases produced by plasma cutting vary based on the material to be cut and the method of cutting, but may include ozone, oxides of nitrogen, hexavalent chromium, hydrogen, and other substances if such are contained in or released by the material being cut.

Caution should be taken to minimize exposure to fumes produced by any industrial process. Depending upon the chemical composition and concentration of the fumes (as well as other factors, such as ventilation), there may be a risk of physical illness, such as birth defects or cancer.

It is the responsibility of the equipment and site owner to test the air quality in the area where the equipment is used and to ensure that the air quality in the workplace meets all local and national standards and regulations.

The air quality level in any relevant workplace depends on site-specific variables such as:

- Table design (wet, dry, underwater).
- Material composition, surface finish, and composition of coatings.
- Volume of material removed.
- Duration of cutting or gouging.
- Size, air volume, ventilation and filtration of the work area.
- Personal protective equipment.
- Number of welding and cutting systems in operation.
- Other site processes that may produce fumes.

If the workplace must conform to national or local regulations, only monitoring or testing done at the site can determine whether the site is above or below allowable levels.

To reduce the risk of exposure to fumes:

- Remove all coatings and solvents from the metal before cutting.
- Use local exhaust ventilation to remove fumes from the air.
- Do not inhale fumes. Wear an air-supplied respirator when cutting any metal coated with, containing, or suspected to contain toxic elements.
- Assure that those using welding or cutting equipment, as well as air-supplied respiration devices, are qualified and trained in the proper use of such equipment.
- Never cut containers with potentially toxic materials inside. Empty and properly clean the container first.
- Monitor or test the air quality at the site as needed.
- Consult with a local expert to implement a site plan to ensure safe air quality.



A PLASMA ARC CAN CAUSE INJURY AND BURNS

Instant-On Torches

Plasma arc comes on immediately when the torch switch is activated.

The plasma arc will cut quickly through gloves and skin.

- Keep away from the torch tip.
- Do not hold metal near the cutting path.
- Never point the torch toward yourself or others.



ARC RAYS CAN BURN EYES AND SKIN

Eye Protection Plasma arc rays produce intense visible and invisible (ultraviolet and infrared) rays that can burn eyes and skin.

- Use eye protection in accordance with applicable national or local codes.
- Wear eye protection (safety glasses or goggles with side shields, and a welding helmet) with appropriate lens shading to protect your eyes from the arc's ultraviolet and infrared rays.

Skin Protection Wear protective clothing to protect against burns caused by ultraviolet light, sparks and hot metal.

- Gauntlet gloves, safety shoes and hat.
- Flame-retardant clothing to cover all exposed areas.
- Cuffless trousers to prevent entry of sparks and slag.
- Remove any combustibles, such as a butane lighter or matches, from your pockets before cutting.

Arc Current

Up to 100 A
100-200 A
200-400 A
Over 400 A



Lens Shade

AWS (USA)	ISO 4850
No. 8	No. 11
No. 10	No. 11-12
No. 12	No. 13
No. 14	No. 14

Cutting Area Prepare the cutting area to reduce reflection and transmission of ultraviolet light:

- Paint walls and other surfaces with dark colors to reduce reflection.
- Use protective screens or barriers to protect others from flash and glare.
- Warn others not to watch the arc. Use placards or signs.



GROUNDING SAFETY

Work Cable Attach the work cable securely to the workpiece or the work table with good metal-to-metal contact. Do not connect it to the piece that will fall away when the cut is complete.

Work Table Connect the work table to an earth ground, in accordance with appropriate national or local electrical codes.

Input Power

- Be sure to connect the power cord ground wire to the ground in the disconnect box.
- If installation of the plasma system involves connecting the power cord to the power supply, be sure to connect the power cord ground wire properly.
- Place the power cord's ground wire on the stud first, then place any other ground wires on top of the power cord ground. Fasten the retaining nut tightly.
- Tighten all electrical connections to avoid excessive heating.

COMPRESSED GAS EQUIPMENT SAFETY

- Never lubricate cylinder valves or regulators with oil or grease.
- Use only correct gas cylinders, regulators, hoses and fittings designed for the specific application.
- Maintain all compressed gas equipment and associated parts in good condition.
- Label and color-code all gas hoses to identify the type of gas in each hose. Consult applicable national or local codes.

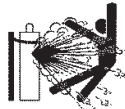

GAS CYLINDERS CAN EXPLODE IF DAMAGED

Gas cylinders contain gas under high pressure. If damaged, a cylinder can explode.

- Handle and use compressed gas cylinders in accordance with applicable national or local codes.
- Never use a cylinder that is not upright and secured in place.
- Keep the protective cap in place over valve except when the cylinder is in use or connected for use.
- Never allow electrical contact between the plasma arc and a cylinder.
- Never expose cylinders to excessive heat, sparks, slag or open flame.
- Never use a hammer, wrench or other tool to open a stuck cylinder valve.



NOISE CAN DAMAGE HEARING

Prolonged exposure to noise from cutting or gouging can damage hearing.

- Use approved ear protection when using plasma system.
- Warn others nearby about the noise hazard.



A PLASMA ARC CAN DAMAGE FROZEN PIPES

Frozen pipes may be damaged or can burst if you attempt to thaw them with a plasma torch.



PACEMAKER AND HEARING AID OPERATION

Pacemaker and hearing aid operation can be affected by magnetic fields from high currents. Pacemaker and hearing aid wearers should consult a doctor before going near any plasma arc cutting and gouging operations.

To reduce magnetic field hazards:

- Keep both the work cable and the torch lead to one side, away from your body.
- Route the torch leads as close as possible to the work cable.
- Do not wrap or drape the torch lead or work cable around your body.
- Keep as far away from the power supply as possible.











ADDITIONAL SAFETY INFORMATION

1. ANSI Standard Z49.1, *Safety in Welding and Cutting*, American Welding Society, 550 LeJeune Road P.O. Box 351020, Miami, FL 33135
2. ANSI Standard Z49.2, *Fire Prevention in the Use of Cutting and Welding Processes*, American National Standards Institute, 1430 Broadway, New York, NY 10018
3. ANSI Standard Z87.1, *Safe Practices for Occupation and Educational Eye and Face Protection*, American National Standards Institute, 1430 Broadway, New York, NY 10018
4. AWS F4.1, *Recommended Safe Practices for the Preparation for Welding and Cutting of Containers and Piping That Have Held Hazardous Substances*, American Welding Society, 550 LeJeune Road, P.O. Box 351040, Miami, FL 33135
5. AWS F5.2, *Recommended Safe Practices for Plasma Arc Cutting*, American Welding Society, 550 LeJeune Road, P.O. Box 351040, Miami, FL 33135
6. CGA Pamphlet P-1, *Safe Handling of Compressed Gases in Cylinders*, Compressed Gas Association, 1235 Jefferson Davis Highway, Arlington, VA 22202
7. CSA Standard W117.2, *Code for Safety in Welding and Cutting*, Canadian Standards Association Standard Sales 178 Rexdale Boulevard, Rexdale, Ontario M9W 1R3, Canada
8. NFPA Standard 51B, *Cutting and Welding Processes*, National Fire Protection Association, 470 Atlantic Avenue, Boston, MA 02210
9. NFPA Standard 70–1978, *National Electrical Code*, National Fire Protection Association, 470 Atlantic Avenue, Boston, MA 02210
10. OSHA, *Safety and Health Standards*, 29FR 1910 U.S. Government Printing Office, Washington, D.C. 20402

SAFETY

WARNING LABEL

This warning label is affixed to some power supplies. It is important that the operator and maintenance technician understand the intent of these warning symbols as described. The numbered text corresponds to the numbered boxes on the label.

 WARNING	 AVERTISSEMENT																																
<p>Protect yourself and others. Read and understand this marking.</p> <ul style="list-style-type: none"> • Disconnect power source before servicing. • Disconnect power source before disassembly of the torch. • Use torches specified in the instruction manual. • This plasma cutting machine must be connected to power source in accordance with applicable electrical codes. • Plasma arc cutting can be injurious to operator and persons in the work area. Before operating, read and understand the manufacturer's instructions and know your employer's safety practices. 	<p>Pour votre protection et celle des autres, lire et comprendre ces consignes.</p> <ul style="list-style-type: none"> • Couper l'alimentation avant d'effectuer le dépannage. • Couper l'alimentation avant de démonter la torche. • Utiliser exclusivement les torches indiquées dans le manuel d'instructions. • Le raccordement au réseau de cette machine de coupage à arc-plasma doit être conforme aux codes de l'électricité pertinents. • Le coupage à arc-plasma comporte des risques pour l'utilisateur et les personnes se trouvant dans la zone de travail. Avant le coupage, lire et comprendre les instructions du fabricant. Appliquer également les consignes de sécurité de votre entreprise. 																																
<p> Electric shock can kill.</p> <ul style="list-style-type: none"> • Do not touch live electrical parts. • Keep all panels and covers in place when the machine is connected to a power source. • Insulate yourself from work and ground: wear insulating gloves, shoes and clothing. • Keep gloves, shoes, clothing, work area, torch and this machinery dry. 	<p> Fumes and gases can injure your health.</p> <ul style="list-style-type: none"> • Keep your head out of the fumes. • Provide ventilation, exhaust at the arc, or both to keep the fumes and gases from your breathing zone and the general area. • If ventilation is inadequate, use an approved respirator. <p>WARNING: This product, when used for welding or cutting, produces fumes or gases which contain chemicals known to the state of California to cause birth defects and, in some cases, cancer.</p>																																
<p> Explosion will result if pressurized containers are cut.</p>	<p> Heat, splatter and sparks cause fire and burns.</p> <ul style="list-style-type: none"> • Do not cut near combustible material. • Do not cut containers that have held combustibles. • Do not have on your person any combustibles such as a butane lighter or matches. 																																
<p> Arc rays can injure eyes and burn skin.</p> <ul style="list-style-type: none"> • Wear correct eye and body protection. 	<p> Pilot arc can cause burns.</p> <ul style="list-style-type: none"> • Keep the torch nozzle away from yourself and others when the switch is depressed. • Wear correct eye and body protection. 																																
DO NOT REMOVE THIS MARKING	NE PAS ENLEVER CET AVIS																																
 WARNING	 AVERTISSEMENT																																
<p>INSTANT START Arc starts instantly after torch switch is depressed.</p>	<p>AMORÇAGE INSTANTANÉ L'arc s'amorce aussitôt qu'on enclenche l'interrupteur de la torche.</p>																																
<table border="1"> <tr> <td>1</td> <td>1,1</td> <td>1,2</td> <td>1,3</td> <td>4</td> <td>4,1</td> <td>4,2</td> <td>4,3</td> </tr> <tr> <td>2</td> <td>2,1</td> <td>2,2</td> <td>2,3</td> <td>5</td> <td>5,1</td> <td colspan="2">+ + +</td> </tr> <tr> <td>3</td> <td>3,1</td> <td>3,2</td> <td>3,3</td> <td>6</td> <td colspan="3">+ + +</td> </tr> <tr> <td colspan="4"></td> <td>7</td> <td colspan="3"></td> </tr> </table>	1	1,1	1,2	1,3	4	4,1	4,2	4,3	2	2,1	2,2	2,3	5	5,1	+ + +		3	3,1	3,2	3,3	6	+ + +							7				<p>110391 Rev A</p>
1	1,1	1,2	1,3	4	4,1	4,2	4,3																										
2	2,1	2,2	2,3	5	5,1	+ + +																											
3	3,1	3,2	3,3	6	+ + +																												
				7																													

1. Cutting sparks can cause explosion or fire.
 - 1.1 Keep flammables away from cutting.
 - 1.2 Keep a fire extinguisher nearby, and have a watchperson ready to use it.
 - 1.3 Do not cut on any closed containers.
2. The plasma arc can cause injury and burns.
 - 2.1 Turn off power before disassembling torch.
 - 2.2 Do not hold the material near cutting path.
 - 2.3 Wear complete body protection.
3. Electric shock from torch or wiring can kill. Protect yourself from electric shock.
 - 3.1 Wear insulating gloves. Do not wear wet or damaged gloves.
 - 3.2 Insulate yourself from work and ground.
 - 3.3 Disconnect input plug or power before working on machine.
4. Breathing cutting fumes can be hazardous to your health.
 - 4.1 Keep your head out of the fumes.
 - 4.2 Use forced ventilation or local exhaust to remove the fumes.
 - 4.3 Use ventilating fan to remove the fumes.
5. Arc rays can burn eyes and injure skin.
 - 5.1 Wear hat and safety glasses. Use ear protection and button shirt collar. Use welding helmet with correct shade of filter. Wear complete body protection.
6. Become trained and read the instructions before working on the machine or cutting.
7. Do not remove or paint over (cover) warning labels.

Section 1a

SÉCURITÉ

Dans cette section :

Identifier les consignes de sécurité	1a-2
Suivre les instructions de sécurité	1a-2
Le coupage peut provoquer un incendie ou une explosion	1a-2
Les chocs électriques peuvent être fatals	1a-3
L'électricité statique peut endommager les cartes de circuits imprimés.....	1a-3
Les vapeurs toxiques peuvent provoquer des blessures ou la mort	1a-4
L'arc plasma peut provoquer des blessures ou des brûlures	1a-5
Les rayons de l'arc peuvent brûler les yeux et la peau	1a-5
Mise à la masse et à la terre	1a-6
Sécurité des bouteilles de gaz comprimé.....	1a-6
Les bouteilles de gaz comprimé peuvent exploser en cas de dommages	1a-6
Le bruit peut provoquer des problèmes auditifs	1a-7
Pacemakers et prothèses auditives	1a-7
Un arc plasma peut endommager les tuyaux gelés	1a-7
Étiquettes de sécurité	1a-8



IDENTIFIER LES CONSIGNES DE SÉCURITÉ

Les symboles indiqués dans cette section sont utilisés pour identifier les risques éventuels. Si vous trouvez un symbole de sécurité, que ce soit dans ce manuel ou sur l'équipement, soyez conscient des risques de blessures et suivez les instructions correspondantes afin d'éviter ces risques.



SUIVRE LES INSTRUCTIONS DE SÉCURITÉ

Lire attentivement toutes les consignes de sécurité dans le présent manuel et sur les étiquettes de sécurité se trouvant sur la machine.

- Les étiquettes de sécurité doivent rester lisibles. Remplacer immédiatement les étiquettes manquantes ou abîmées.
- Apprendre à faire fonctionner la machine et à utiliser correctement les commandes. Ne laisser personne utiliser la machine sans connaître son fonctionnement.

- Garder la machine en bon état. Des modifications non autorisées sur la machine peuvent engendrer des problèmes de sécurité et raccourcir la durée d'utilisation de l'équipement.

DANGER AVERTISSEMENT PRÉCAUTION

Les signaux DANGER ou AVERTISSEMENT sont utilisés avec un symbole de sécurité, DANGER correspondant aux risques les plus sérieux.

- Les étiquettes de sécurité DANGER et AVERTISSEMENT sont situées sur la machine pour signaler certains dangers spécifiques.
- Les messages d'AVERTISSEMENT précèdent les instructions d'utilisation expliquées dans ce manuel et signalent les risques de blessures ou de mort au cas où ces instructions ne seraient pas suivies correctement.
- Les messages de PRÉCAUTION précèdent les instructions d'utilisation contenues dans ce manuel et signalent que le matériel risque d'être endommagé si les instructions ne sont pas suivies correctement.



LE COUPAGE PEUT PROVOQUER UN INCENDIE OU UNE EXPLOSION

Prévention des incendies

- Avant de commencer, s'assurer que la zone de coupage ne présente aucun danger. Conserver un extincteur à proximité.
- Éloigner toute matière inflammable à une distance d'au moins 10 m du poste de coupage.
- Tremper le métal chaud ou le laisser refroidir avant de le manipuler ou avant de le mettre en contact avec des matériaux combustibles.
- Ne jamais couper des récipients pouvant contenir des matières inflammables avant de les avoir vidés et nettoyés correctement.
- Aérer toute atmosphère potentiellement inflammable avant d'utiliser un système plasma.
- Lors de l'utilisation d'oxygène comme gaz plasma, un système de ventilation par aspiration est nécessaire.

Prévention des explosions

- Ne pas couper en présence de poussière ou de vapeurs.
- Ne pas couper de bouteilles, de tuyaux ou autres récipients fermés et pressurisés.
- Ne pas couper de récipients contenant des matières combustibles.



AVERTISSEMENT

Risque d'explosion argon-hydrogène et méthane

L'hydrogène et le méthane sont des gaz inflammables et potentiellement explosifs. Conserver à l'écart de toute flamme les bouteilles et tuyaux contenant des mélanges à base d'hydrogène ou de méthane. Maintenir toute flamme et étincelle à l'écart de la torche lors de l'utilisation d'un plasma d'argon-hydrogène ou de méthane.



AVERTISSEMENT

Détonation de l'hydrogène lors du coupage de l'aluminium

- Lors du coupage de l'aluminium sous l'eau, ou si l'eau touche la partie inférieure de la pièce d'aluminium, de l'hydrogène libre peut s'accumuler sous la pièce à couper et détonner lors du coupage plasma.
- Installer un collecteur d'aération au fond de la table à eau afin d'éliminer les risques de détonation de l'hydrogène. Se référer à l'annexe du manuel pour plus de renseignements sur les collecteurs d'aération.



LES CHOCS ÉLECTRIQUES PEUVENT ÊTRE FATALS

Toucher une pièce électrique sous tension peut provoquer un choc électrique fatal ou des brûlures graves.

- La mise en fonctionnement du système plasma ferme un circuit électrique entre la torche et la pièce à couper. La pièce à couper et tout autre élément en contact avec cette pièce font partie du circuit électrique.
- Ne jamais toucher le corps de la torche, la pièce à couper ou l'eau de la table à eau pendant le fonctionnement du système plasma.

Prévention des chocs électriques

Tous les systèmes plasma Hypertherm utilisent des hautes tensions pour le coupage (souvent de 200 à 400 V). On doit prendre les précautions suivantes quand on utilise le système plasma :

- Porter des bottes et des gants isolants et garder le corps et les vêtements au sec.
- Ne pas se tenir, s'asseoir ou se coucher sur une surface mouillée, ni la toucher quand on utilise le système plasma.
- S'isoler de la surface de travail et du sol en utilisant des tapis isolants secs ou des couvertures assez grandes pour éviter tout contact physique avec le travail ou le sol. S'il s'avère nécessaire de travailler dans ou près d'un endroit humide, procéder avec une extrême prudence.
- Installer un sectionneur avec fusibles appropriés, à proximité de la source de courant. Ce dispositif permet à l'opérateur d'arrêter rapidement la source de courant en cas d'urgence.
- En cas d'utilisation d'une table à eau, s'assurer que cette dernière est correctement mise à la terre.

- Installer et mettre à la terre l'équipement selon les instructions du présent manuel et conformément aux codes électriques locaux et nationaux.
- Inspecter fréquemment le cordon d'alimentation primaire pour s'assurer qu'il n'est ni endommagé, ni fendu. Remplacer immédiatement un cordon endommagé.

Un câble dénudé peut tuer.

- Inspecter et remplacer les câbles de la torche qui sont usés ou endommagés.
- Ne pas saisir la pièce à couper ni les chutes lors du coupage. Laisser la pièce à couper en place ou sur la table de travail, le câble de retour connecté lors du coupage.
- Avant de vérifier, de nettoyer ou de remplacer les pièces de la torche, couper l'alimentation ou débrancher la prise de courant.
- Ne jamais contourner ou court-circuiter les verrouillages de sécurité.
- Avant d'enlever le capot du système ou de la source de courant, couper l'alimentation électrique. Attendre ensuite 5 minutes pour que les condensateurs se déchargent.
- Ne jamais faire fonctionner le système plasma sans que les capots de la source de courant ne soient en place. Les raccords exposés de la source de courant sont extrêmement dangereux.
- Lors de l'installation des connexions, attacher tout d'abord la prise de terre appropriée.
- Chaque système plasma Hypertherm est conçu pour être utilisé uniquement avec des torches Hypertherm spécifiques. Ne pas utiliser des torches inappropriées qui pourraient surchauffer et présenter des risques pour la sécurité.



L'ÉLECTRICITÉ STATIQUE PEUT ENDOMMAGER LES CARTES DE CIRCUITS IMPRIMÉS

On doit prendre les précautions qui s'imposent quand on manipule les circuits imprimés.

- On doit ranger les cartes de circuits imprimés dans des contenants antistatiques.
- On doit porter un bracelet antistatique quand on manipule les cartes de circuits imprimés.



LES VAPEURS TOXIQUES PEUVENT PROVOQUER DES BLESSURES OU LA MORT

L'arc plasma est lui-même la source de chaleur utilisée pour le coupage. Par conséquent, bien que l'arc plasma n'ait pas été reconnu comme une source de vapeurs toxiques, le matériau coupé peut être une source de vapeurs ou de gaz toxiques qui épuisent l'oxygène.

Les vapeurs produites varient selon le métal coupé. Les métaux qui peuvent dégager des vapeurs toxiques comprennent, entre autres, l'acier inoxydable, l'acier au carbone, le zinc (galvanisé) et le cuivre.

Dans certains cas, le métal peut être revêtu d'une substance susceptible de dégager des vapeurs toxiques. Les revêtements toxiques comprennent entre autres, le plomb (dans certaines peintures), le cadmium (dans certaines peintures et enduits) et le béryllium.

Les gaz produits par le coupage plasma varient selon le matériau à couper et la méthode de coupage, mais ils peuvent comprendre l'ozone, les oxydes d'azote, le chrome hexavalent, l'hydrogène et autres substances présentes dans le matériau coupé ou en émanent.

On doit prendre les précautions qui s'imposent pour réduire au minimum l'exposition aux vapeurs produites par tout processus industriel. Selon la composition chimique et la concentration des vapeurs (ainsi que d'autres facteurs comme la ventilation), il peut y avoir un risque de maladie physique, comme des malformations ou le cancer.

Il incombe au propriétaire du matériel et du site de vérifier la qualité de l'air dans le secteur où l'on utilise le matériel et de s'assurer que la qualité de l'air sur les lieux de travail répond aux normes et réglementation locales et nationales.

Le niveau de qualité de l'air dans tout lieu de travail dépend des variables propres au site comme :

- Type de table (humide, sèche, sous l'eau).
- Composition du matériau, fini de la surface et composition des revêtements.
- Volume de matériau enlevé.
- Durée du coupage ou du gougeage.
- Dimensions, volume d'air, ventilation et filtration de la zone de travail.
- Équipement de protection individuelle.
- Nombre de systèmes de soudage et de coupage en fonctionnement.
- Autres procédés du site qui peuvent produire des vapeurs.

Si les lieux de travail doivent être conformes aux règlements nationaux ou locaux, seuls les contrôles ou les essais effectués au site peuvent déterminer si celui-ci se situe au-dessus ou au-dessous des niveaux admissibles.

Pour réduire le risque d'exposition aux vapeurs :

- Éliminer tout revêtement et solvant du métal avant le coupage.
- Utiliser la ventilation d'extraction locale pour éliminer les vapeurs de l'air.
- Ne pas inhaler les vapeurs. Porter un respirateur à adduction d'air quand on coupe des métaux revêtus d'éléments toxiques ou qui en contiennent ou sont susceptibles d'en contenir.
- S'assurer que les personnes qui utilisent un matériel de soudage ou de coupage ainsi que les dispositifs de respiration par adduction d'air sont qualifiés et ont reçu la formation sur la bonne utilisation d'un tel matériel.
- Ne jamais couper les contenants dans lesquels il peut y avoir des matériaux toxiques. En premier lieu, vider et nettoyer correctement le contenant.
- Contrôler ou éprouver la qualité de l'air au site selon les besoins.
- Consulter un expert local pour mettre en œuvre un plan du site afin d'assurer une qualité de l'air sûre.



L'ARC PLASMA PEUT PROVOQUER DES BLESSURES OU DES BRÛLURES

Torches à allumage instantané

L'arc plasma s'allume immédiatement après que la torche soit mise en marche.

L'arc plasma coupe facilement les gants et la peau.

- Rester éloigné de l'extrémité de la torche.
- Ne pas tenir de métal près de la trajectoire de coupe.
- Ne jamais pointer la torche vers soi ou d'autres personnes.



LES RAYONS DE L'ARC PEUVENT BRÛLER LES YEUX ET LA PEAU

Protection des yeux Les rayons de l'arc plasma produisent de puissants rayons visibles ou invisibles (ultraviolets et infrarouges) qui peuvent brûler les yeux et la peau.

- Utiliser des lunettes de sécurité conformément aux codes locaux ou nationaux en vigueur.
- Porter des lunettes de protection (lunettes ou masque muni d'écrans latéraux et encore masque de soudure) avec des verres teintés appropriés pour protéger les yeux des rayons ultraviolets et infrarouges de l'arc.

Protection de la peau Porter des vêtements de sécurité pour se protéger contre les brûlures que peuvent causer les rayons ultraviolets, les étincelles et le métal brûlant :

- Gants à crispin, chaussures et casque de sécurité.
- Vêtements ignifuges couvrant toutes les parties exposées du corps.
- Pantalon sans revers pour éviter que des étincelles ou des scories puissent s'y loger.
- Avant le coupage, retirer de ses poches tout objet combustible comme les briquets au butane ou les allumettes.

Courant de l'arc

Jusqu'à 100 A
100-200 A
200-400 A
Plus de 400 A



Puissance des verres teintés

	AWS (É.-U.)	ISO 4850
Jusqu'à 100 A	N° 8	N° 11
100-200 A	N° 10	N° 11-12
200-400 A	N° 12	N° 13
Plus de 400 A	N° 14	N° 14

Zone de coupage Préparer la zone de coupage afin de réduire la réverbération et la transmission de la lumière ultraviolette :

- Peindre les murs et autres surfaces de couleur sombre pour réduire la réflexion de la lumière.
- Utiliser des écrans et autres dispositifs de protection afin de protéger les autres personnes de la lumière et de la réverbération.
- Prévenir les autres personnes de ne pas regarder l'arc. Utiliser des affiches ou des panneaux.



MISE À LA MASSE ET À LA TERRE

Câble de retour Bien fixer le câble de retour (ou de masse) à la pièce à couper ou à la table de travail de façon à assurer un bon contact métal-métal. Ne pas fixer le câble de retour à la partie de la pièce qui doit se détacher.

Table de travail Raccorder la table de travail à la terre, conformément aux codes de sécurité locaux ou nationaux appropriés.

Alimentation

- S'assurer que le fil de terre du cordon d'alimentation est connecté à la terre dans le coffret du sectionneur.
- S'il est nécessaire de brancher le cordon d'alimentation à la source de courant lors de l'installation du système, s'assurer que le fil de terre est correctement branché.
- Placer tout d'abord le fil de terre du cordon d'alimentation sur le plot de mise à la terre puis placer les autres fils de terre par-dessus. Bien serrer l'écrou de retenue.
- S'assurer que toutes les connexions sont bien serrées pour éviter la surchauffe.

SÉCURITÉ DES BOUTEILLES DE GAZ COMPRIMÉ

- Ne jamais lubrifier les robinets des bouteilles ou les régulateurs avec de l'huile ou de la graisse.
- Utiliser uniquement les bouteilles, régulateurs, tuyaux et accessoires appropriés et conçus pour chaque application spécifique.
- Entretenir l'équipement et les pièces d'équipement à gaz comprimé afin de les garder en bon état.
- Étiqueter et coder avec des couleurs tous les tuyaux de gaz afin d'identifier le type de gaz contenu dans chaque tuyau. Se référer aux codes locaux ou nationaux en vigueur.



LES BOUTEILLES DE GAZ COMPRIMÉ PEUVENT EXPLOSER EN CAS DE DOMMAGES

Les bouteilles de gaz contiennent du gaz à haute pression. Si une bouteille est endommagée, elle peut exploser.

- Manipuler et utiliser les bouteilles de gaz comprimé conformément aux codes locaux ou nationaux.
- Ne jamais utiliser une bouteille qui n'est pas placée à la verticale et bien assujettie.
- Le capuchon de protection doit être placé sur le robinet sauf si la bouteille est en cours d'utilisation ou connectée pour utilisation.
- Éviter à tout prix le contact électrique entre l'arc plasma et une bouteille.
- Ne jamais exposer des bouteilles à une chaleur excessive, aux étincelles, aux scories ou aux flammes nues.
- Ne jamais utiliser des marteaux, des clés ou d'autres outils pour débloquer le robinet des bouteilles.



LE BRUIT PEUT PROVOQUER DES PROBLÈMES AUDITIFS

Une exposition prolongée au bruit du coupage ou du gougeage peut provoquer des problèmes auditifs.

- Utiliser un casque de protection homologué lors de l'utilisation du système plasma.
- Prévenir les personnes aux alentours des risques encourus en cas d'exposition au bruit.



UN ARC PLASMA PEUT ENDOMMAGER LES TUYAUX GELÉS

Les tuyaux gelés peuvent être endommagés ou éclater si l'on essaie de les dégeler avec une torche plasma.



PACEMAKERS ET PROTHÈSES AUDITIVES

Les champs magnétiques produits par les courants à haute tension peuvent affecter le fonctionnement des prothèses auditives et des pacemakers. Les personnes portant ce type d'appareil doivent consulter un médecin avant de s'approcher d'un lieu où s'effectue le coupage ou le gougeage plasma.

Pour réduire les risques associés aux champs magnétiques :

- Garder loin de soi et du même côté du corps le câble de retour et le faisceau de la torche.
- Faire passer le faisceau de la torche le plus près possible du câble de retour.
- Ne pas s'enrouler le faisceau de la torche ou le câble de retour autour du corps.
- Se tenir le plus loin possible de la source de courant.

Étiquette de sécurité

Cette étiquette est affichée sur la source de courant. Il est important que l'utilisateur et le technicien de maintenance comprennent la signification des symboles de sécurité. Les numéros de la liste correspondent aux numéros des images.

WARNING	AVERTISSEMENT																												
<p>Protect yourself and others. Read and understand this marking.</p> <ul style="list-style-type: none"> Disconnect power source before servicing. Disconnect power source before disassembly of the torch. Use torches specified in the instruction manual. This plasma cutting machine must be connected to power source in accordance with applicable electrical codes. Plasma arc cutting can be injurious to operator and persons in the work area. Before operating, read and understand the manufacturer's instructions and know your employer's safety practices. 	<p>Pour votre protection et celle des autres, lire et comprendre ces consignes.</p> <ul style="list-style-type: none"> Couper l'alimentation avant d'effectuer le dépannage. Couper l'alimentation avant de démonter la torche. Utiliser exclusivement les torches indiquées dans le manuel d'instructions. Le raccordement au réseau de cette machine de coupage à arc-plasma doit être conforme aux codes de l'électricité pertinents. Le coupage à arc-plasma comporte des risques pour l'utilisateur et les personnes se trouvant dans la zone de travail. Avant le coupage, lire et comprendre les instructions du fabricant. Appliquer également les consignes de sécurité de votre entreprise. 																												
<p> Electric shock can kill.</p> <ul style="list-style-type: none"> Do not touch live electrical parts. Keep all panels and covers in place when the machine is connected to a power source. Insulate yourself from work and ground: wear insulating gloves, shoes and clothing. Keep gloves, shoes, clothing, work area, torch and this machinery dry. 	<p> Fumes and gases can injure your health.</p> <ul style="list-style-type: none"> Keep your head out of the fumes. Provide ventilation, exhaust at the arc, or both to keep the fumes and gases from your breathing zone and the general area. If ventilation is inadequate, use an approved respirator. <p>WARNING: This product, when used for welding or cutting, produces fumes or gases which contain chemicals known to the state of California to cause birth defects and, in some cases, cancer.</p> <p>Heat, splatter and sparks cause fire and burns.</p> <ul style="list-style-type: none"> Do not cut near combustible material. Do not cut containers that have held combustibles. Do not have on your person any combustibles such as a butane lighter or matches. <p>Pilot arc can cause burns.</p> <ul style="list-style-type: none"> Keep the torch nozzle away from yourself and others when the switch is depressed. Wear correct eye and body protection. 																												
<p> Explosion will result if pressurized containers are cut.</p>	<p> Heat, splatter and sparks cause fire and burns.</p>																												
<p> Arc rays can injure eyes and burn skin.</p> <ul style="list-style-type: none"> Wear correct eye and body protection. 	<p> Pilot arc can cause burns.</p>																												
<p> Noise can damage hearing.</p> <ul style="list-style-type: none"> Wear correct ear protection. 	<p> Pilot arc can cause burns.</p>																												
DO NOT REMOVE THIS MARKING	NE PAS ENLEVER CET AVIS																												
WARNING	AVERTISSEMENT																												
<p>INSTANT START Arc starts instantly after torch switch is depressed.</p>	<p>AMORÇAGE INSTANTANÉ L'arc s'amorce aussitôt qu'on enclenche l'interrupteur de la torche.</p>																												
<table border="1" style="width: 100%; text-align: center;"> <tr> <td>1</td><td>1.1</td><td>1.2</td><td>1.3</td> </tr> <tr> <td>2</td><td>2.1</td><td>2.2</td><td>2.3</td> </tr> <tr> <td>3</td><td>3.1</td><td>3.2</td><td>3.3</td> </tr> </table>	1	1.1	1.2	1.3	2	2.1	2.2	2.3	3	3.1	3.2	3.3	<table border="1" style="width: 100%; text-align: center;"> <tr> <td>4</td><td>4.1</td><td>4.2</td><td>4.3</td> </tr> <tr> <td>5</td><td>5.1</td><td colspan="2"></td> </tr> <tr> <td>6</td><td colspan="3"></td> </tr> <tr> <td>7</td><td colspan="3"></td> </tr> </table>	4	4.1	4.2	4.3	5	5.1			6				7			
1	1.1	1.2	1.3																										
2	2.1	2.2	2.3																										
3	3.1	3.2	3.3																										
4	4.1	4.2	4.3																										
5	5.1																												
6																													
7																													

1. Les étincelles produites par le coupage peuvent provoquer une explosion ou un incendie.
 - 1.1 Pendant le coupage, éloigner toute matière inflammable.
 - 1.2 Conserver un extincteur à proximité et s'assurer qu'une personne soit prête à l'utiliser.
 - 1.3 Ne jamais couper de récipients fermés.
2. L'arc plasma peut provoquer des blessures et des brûlures.
 - 2.1 Couper l'alimentation avant de démonter la torche.
 - 2.2 Ne pas tenir la surface à couper près de la trajectoire de coupe.
 - 2.3 Porter des vêtements de protection couvrant tout le corps.
3. Un choc électrique causé par la torche ou les câbles peut être fatal. Se protéger contre les risques de chocs électriques.
 - 3.1 Porter des gants isolants. Ne pas porter de gants mouillés ou abîmés.
 - 3.2 S'isoler de la surface de travail et du sol.
 - 3.3 Débrancher la prise ou la source de courant avant de manipuler l'équipement.
4. L'inhalation des vapeurs produites par le coupage peut être dangereuse pour la santé.
 - 4.1 Garder le visage à l'écart des vapeurs.
 - 4.2 Utiliser un système de ventilation par aspiration ou d'échappement localisé pour dissiper les vapeurs.
 - 4.3 Utiliser un ventilateur pour dissiper les vapeurs.
5. Les rayons de l'arc peuvent brûler les yeux et provoquer des lésions de la peau.
 - 5.1 Porter un casque et des lunettes de sécurité. Se protéger les oreilles et porter une chemise dont le col peut être déboutonné. Porter un casque de soudure dont la protection filtrante est suffisante. Porter des vêtements protecteurs couvrant la totalité du corps.
6. Se former à la technique du coupage et lire les instructions avant de manipuler l'équipement ou de procéder au coupage.
7. Ne pas retirer ou peindre (recouvrir) les étiquettes de sécurité.

Sección 1b

SEGURIDAD

En esta sección:

Reconocimiento de información de seguridad	1b-2
Siga las instrucciones de seguridad	1b-2
Los cortes pueden provocar incendios o explosiones.....	1b-2
El choque eléctrico puede provocar la muerte	1b-3
Electricidad estática puede dañar tablillas de circuito	1b-3
Humos tóxicos pueden causar lesiones o muerte.....	1b-4
El arco de plasma puede causar lesiones y quemaduras.....	1b-5
Los rayos del arco pueden producir quemaduras en los ojos y en la piel.....	1b-5
Seguridad de toma a tierra	1b-6
Seguridad de los equipos de gas comprimido	1b-6
Los cilindros de gas pueden explotar si están dañados.....	1b-6
El ruido puede deteriorar la audición.....	1b-7
Operación de marcapasos y de audífonos.....	1b-7
Un arco plasma puede dañar tubos congelados	1b-7
Etiquetas de advertencia.....	1b-8



RECONOCIMIENTO DE INFORMACIÓN DE SEGURIDAD

Los símbolos que se muestran en esta sección se utilizan para identificar los posibles peligros. Cuando vea un símbolo de seguridad en este manual o en su máquina, recuerde que existe la posibilidad de que se produzcan lesiones personales y siga las instrucciones correspondientes para evitar el peligro.



SIGA LAS INSTRUCCIONES DE SEGURIDAD

Lea atentamente todos los mensajes de seguridad de este manual y las etiquetas de seguridad en su máquina.

- Mantenga las etiquetas de seguridad de su máquina en buen estado. Reemplace las etiquetas que se pierdan o se dañen inmediatamente.
- Aprenda a utilizar la máquina y a utilizar los controles de la manera correcta. No permita que sea utilizada por alguien que no conozca su funcionamiento.

- Mantenga su máquina en buenas condiciones de funcionamiento. La realización de modificaciones no autorizadas a la máquina puede comprometer la seguridad y la vida útil de la máquina.

PELIGRO ADVERTENCIA PRECAUCIÓN

Las palabras PELIGRO y ADVERTENCIA se utilizan conjuntamente con un símbolo de seguridad. La palabra PELIGRO se utiliza para identificar los mayores peligros.

- Encontrará etiquetas de seguridad con las inscripciones PELIGRO y ADVERTENCIA en su máquina, junto a peligros específicos.
- En este manual, la palabra ADVERTENCIA va seguida de instrucciones que, si no se siguen correctamente, pueden provocar lesiones e inclusive la muerte.
- En este manual, la palabra PRECAUCIÓN va seguida de instrucciones que, si no se siguen correctamente, pueden provocar daños en el equipo.



LOS CORTES PUEDEN PROVOCAR INCENDIOS O EXPLOSIONES

Prevención ante el fuego

- Asegúrese de que el área sea segura antes de proceder a cortar. Tenga a mano un extinguidor de incendios.
- Retire todos los materiales inflamables, colocándolos a por lo menos 10 metros del área de corte.
- Remoje los metales calientes o permita que se enfríen antes de que entren en contacto con materiales combustibles.
- Nunca corte depósitos que contengan materiales inflamables – primero es necesario vaciarlos y limpiarlos debidamente.
- Antes de realizar cortes en atmósferas potencialmente inflamables, asegúrese de ventilar bien.
- Al realizar cortes utilizando oxígeno como gas plasma, se requiere tener un sistema de ventilación de escape.

Prevención ante explosiones

- No corte en atmósferas que contengan polvo o vapores explosivos.
- No corte depósitos o tubos a presión ni cualquier depósito cerrado.
- No corte depósitos que hayan contenido materiales combustibles.



ADVERTENCIA

Peligro de explosión
Argón-Hidrógeno y metano

El hidrógeno y el metano son gases inflamables que suponen un peligro de explosión. Mantenga el fuego lejos de los cilindros y las mangueras que contengan mezclas de hidrógeno o metano. Mantenga la llama y las chispas lejos de la antorcha al utilizar metano o argón-hidrógeno como plasma.



ADVERTENCIA

Detonación de hidrógeno con
el corte de aluminio

- Al cortar aluminio bajo agua o con agua en contacto con el lado inferior del aluminio, puede acumularse gas hidrógeno bajo la pieza a cortar y detonar durante la operación de corte por plasma.
- Instale un múltiple de aireación en el fondo de la mesa de agua para eliminar la posibilidad de la detonación del hidrógeno. Consulte la sección del apéndice de este manual para conocer detalles acerca del múltiple de aireación.



EL CHOQUE ELÉCTRICO PUEDE PROVOCAR LA MUERTE

El contacto directo con piezas eléctricas conectadas puede provocar un electrochoque fatal o quemaduras graves.

- Al hacer funcionar el sistema de plasma, se completa un circuito eléctrico entre la antorcha y la pieza a cortar. La pieza a cortar es una parte del circuito eléctrico, como también cualquier cosa que se encuentre en contacto con ella.
- Nunca toque el cuerpo de la antorcha, la pieza a cortar o el agua en una mesa de agua cuando el sistema de plasma se encuentre en funcionamiento.

Prevención ante el electrochoque

Todos los sistemas por plasma de Hypertherm usan alto voltaje en el proceso de corte (son comunes los voltajes CD de 200 a 400). Tome las siguientes precauciones cuando se utiliza el equipo de plasma:

- Use guantes y botas aislantes y mantenga el cuerpo y la ropa secos.
- No se siente, se pare o se ponga sobre cualquier superficie húmeda cuando esté trabajando con el equipo.
- Aíslese eléctricamente de la pieza a cortar y de la tierra utilizando alfombrillas o cubiertas de aislamiento secas lo suficientemente grandes como para impedir todo contacto físico con la pieza a cortar o con la tierra. Si su única opción es trabajar en una área húmeda o cerca de ella, sea muy cauteloso.
- Instale un interruptor de corriente adecuado en cuanto a fusibles, en una pared cercana a la fuente de energía. Este interruptor permitirá al operador desconectar rápidamente la fuente de energía en caso de emergencia.
- Al utilizar una mesa de agua, asegúrese de que ésta se encuentre correctamente conectada a la toma a tierra.

- Instale este equipo y conéctelo a tierra según el manual de instrucciones y de conformidad con los códigos locales y nacionales.
- Inspeccione el cordón de alimentación primaria con frecuencia para asegurarse de que no esté dañado ni agrietado. Si el cordón de alimentación primaria está dañado, reemplácelo inmediatamente. **Un cable pelado puede provocar la muerte.**
- Inspeccione las mangueras de la antorcha y reemplácelas cuando se encuentren dañadas.
- No toque la pieza ni los recortes cuando se está cortando. Deje la pieza en su lugar o sobre la mesa de trabajo con el cable de trabajo conectado en todo momento.
- Antes de inspeccionar, limpiar o cambiar las piezas de la antorcha, desconecte la potencia primaria o desenchufe la fuente de energía.
- Nunca evite o descuide los bloqueos de seguridad.
- Antes de retirar la cubierta de una fuente de energía o del gabinete de un sistema, desconecte la potencia primaria de entrada. Espere 5 minutos después de desconectar la potencia primaria para permitir la descarga de los condensadores.
- Nunca opere el sistema de plasma sin que las tapas de la fuente de energía estén en su lugar. Las conexiones expuestas de la fuente de energía presentan un serio riesgo eléctrico.
- Al hacer conexiones de entrada, conecte el conductor de conexión a tierra en primer lugar.
- Cada sistema de plasma Hypertherm está diseñado para ser utilizado sólo con antorchas Hypertherm específicas. No utilice antorchas diferentes, que podrían recalentarse y ser peligrosas.



ELECTRICIDAD ESTÁTICA PUEDE DAÑAR TABLILLAS DE CIRCUITO

Use precauciones adecuadas cuando maneje tablillas impresas de circuito

- Almacene las tablillas PC en recipientes antiestáticos.
- Use la defensa de muñeca conectada a tierra cuando maneje tablillas PC.



HUMOS TÓXICOS PUEDEN CAUSAR LESIONES O MUERTE

El arco plasma es por sí solo la fuente de calor que se usa para cortar. Según esto, aunque el arco de plasma no ha sido identificado como la fuente de humo tóxico, el material que se corta puede ser la fuente de humo o gases tóxicos que vacían el oxígeno.

El humo producido varía según el metal que está cortándose. Metales que pueden liberar humo tóxico incluyen, pero no están limitados a, acero inoxidable, acero al carbón, cinc (galvanizado), y cobre.

En algunos casos, el metal puede estar recubierto con una sustancia que podría liberar humos tóxicos. Los recubrimientos tóxicos incluyen, pero no están limitados a, plomo (en algunas pinturas), cadmio (en algunas pinturas y rellenos), y berilio.

Los gases producidos por el corte por plasma varían basándose en el material a cortarse y el método de cortar, pero pueden incluir ozono, óxidos de nitrógeno, cromo hexavalente, hidrógeno, y otras sustancias, si están contenidas dentro o liberadas por el material que se corta.

Se debe tener cuidado de minimizar la exposición del humo producido por cualquier proceso industrial. Según la composición química y la concentración del humo (al igual que otros factores, tales como ventilación), puede haber el riesgo de enfermedad física, tal como defectos de natioidad o cáncer.

Es la responsabilidad del dueño del equipo y instalación el comprobar la calidad de aire en el lugar donde se está usando el equipo para garantizar que la calidad del aire en el lugar de trabajo cumpla con todas las normas y reglamentos locales y nacionales.

El nivel de la calidad del aire en cualquier lugar de trabajo relevante depende en variables específicas al sitio tales como:

- Diseño de mesa (mojada, seca, bajo agua).
- La composición del material, el acabado de la superficie, y la composición de los recubrimientos.
- Volumen que se quita del material.
- La duración del corte o ranura.
- Tamaño, volumen del aire, ventilación y filtración del lugar de trabajo.
- Equipo de protección personal.
- Número de sistemas de soldar y cortar en la operación.
- Otros procesos del lugar que pueden producir humo.

Si el lugar de trabajo debe cumplir reglamentos nacionales o locales, solamente el monitoreo o las pruebas que se hacen en el lugar pueden determinar si el sitio está encima o debajo de los niveles permitidos.

Para reducir el riesgo de exposición a humo:

- Quite todos los recubrimientos y solventes del metal antes de cortar.
- Use ventilación extractora local para quitar humo del aire.
- No inhale el humo. Use un respirador con fuente propia de aire cuando corte cualquier metal recubierto con, o sospechado de contener, elementos tóxicos.
- Garantice que aquéllos usando equipo de soldar o cortar, al igual que aparatos de respiración con aire propio de aire, estén capacitados y entrenados en el uso apropiado de tal equipo.
- Nunca corte recipientes con materiales potencialmente tóxicos adentro. Primero, vacíe y limpie el recipiente adecuadamente.
- Monitoree o compruebe la calidad del aire en el sitio como fuera necesario.
- Consulte con un experto local para realizar un plan al sitio para garantizar la calidad de aire seguro.



EL ARCO DE PLASMA PUEDE CAUSAR LESIONES Y QUEMADURAS

Antorchas de encendido instantáneo

El arco de plasma se enciende inmediatamente después de activarse el interruptor de la antorcha.

El arco de plasma puede cortar a través de guantes y de la piel con rapidez.

- Manténgase alejado de la punta de la antorcha.
- No sostenga el metal junto al trayecto de corte.
- Nunca apunte la antorcha hacia Ud. mismo o hacia otras personas.



LOS RAYOS DEL ARCO PUEDEN PRODUCIR QUEMADURAS EN LOS OJOS Y EN LA PIEL

Protección para los ojos Los rayos del arco de plasma producen rayos intensos visibles e invisibles (ultravioleta e infrarrojo) que pueden quemar los ojos y la piel.

- Utilice protección para los ojos de conformidad con los códigos locales o nacionales aplicables.
- Colóquese protectores para los ojos (gafas o anteojos protectores con protectores laterales, y bien un casco de soldar) con lentes con sombreado adecuado para proteger sus ojos de los rayos ultravioleta e infrarrojos del arco.

Protección para la piel Vista ropa de protección para proteger la piel contra quemaduras causadas por la radiación ultravioleta de alta intensidad, por las chispas y por el metal caliente:

- Guantes largos, zapatos de seguridad y gorro.
- Roipa de combustión retardada y que cubra todas las partes expuestas.
- Pantalones sin dobladillos para impedir que recojan chispas y escorias.
- Retire todo material combustible de los bolsillos, como encendedores a butano e inclusive cerillas, antes de comenzar a cortar.

Número del cristal

Corriente del arco

- Hasta 100A
- 100-200 A
- 200-400 A
- Más de 400 A



AWS (EE.UU.) ISO 4850

- | | |
|--------|-----------|
| No. 8 | No. 11 |
| No. 10 | No. 11-12 |
| No. 12 | No. 13 |
| No. 14 | No. 14 |

Área de corte Prepare el área de corte para reducir la reflexión y la transmisión de la luz ultravioleta:

- Pinte las paredes y demás superficies con colores oscuros para reducir la reflexión.
- Utilice pantallas o barreras protectoras para proteger a los demás de los destellos.
- Advierta a los demás que no debe mirarse el arco. Utilice carteles o letreros.



SEGURIDAD DE TOMA A TIERRA

Cable de trabajo La pinza del cable de trabajo debe estar bien sujeta a la pieza y hacer un buen contacto de metal a metal con ella o bien con la mesa de trabajo. No conecte el cable con la parte que va a quedar separada por el corte.

Mesa de trabajo Conecte la mesa de trabajo a una buena toma de tierra, de conformidad con los códigos eléctricos nacionales o locales apropiados.

Potencia primaria de entrada

- Asegúrese de que el alambre de toma a tierra del cordón de alimentación está conectado al terminal de tierra en la caja del interruptor de corriente.
- Si la instalación del sistema de plasma supone la conexión del cordón de alimentación primaria a la fuente de energía, asegúrese de conectar correctamente el alambre de toma a tierra del cordón de alimentación primaria.
- Coloque en primer lugar el alambre de toma a tierra del cordón de alimentación primaria en el espárrago luego coloque cualquier otro alambre de tierra sobre el conductor de tierra del cable. Ajuste firmemente la tuerca de retención.
- Asegúrese de que todas las conexiones eléctricas están firmemente realizadas para evitar sobrecalentamientos.

SEGURIDAD DE LOS EQUIPOS DE GAS COMPRIMIDO

- Nunca lubrique reguladores o válvulas de cilindros con aceite o grasa.
- Utilice solamente cilindros, reguladores, mangueras y conectores de gas correctos que hayan sido diseñados para la aplicación específica.
- Mantenga todo el equipo de gas comprimido y las piezas relacionadas en buen estado.
- Coloque etiquetas y códigos de color en todas las mangueras de gas para identificar el tipo de gas que conduce cada una. Consulte los códigos locales o nacionales aplicables.

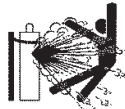

LOS CILINDROS DE GAS PUEDEN EXPLOTAR SI ESTÁN DAÑADOS

Los cilindros de gas contienen gas bajo alta presión. Un cilindro dañado puede explotar.

- Manipule y utilice los cilindros de gas comprimido de acuerdo con los códigos locales o nacionales aplicables.
- No use nunca un cilindro que no esté de pie y bien sujeto.
- Mantenga la tapa de protección en su lugar encima de la válvula, excepto cuando el cilindro se encuentre en uso o conectado para ser utilizado.
- No permita nunca el contacto eléctrico entre el arco de plasma y un cilindro.
- No exponga nunca los cilindros a calor excesivo, chispas, escorias o llamas.
- No emplee nunca martillos, llaves u otro tipo de herramientas para abrir de golpe la válvula del cilindro.



**EL RUIDO PUEDE
DETERIORAR LA AUDICIÓN**

La exposición prolongada al ruido propio de las operaciones de corte y ranurado puede dañar la audición.

- Utilice un método de protección de los oídos aprobado al utilizar el sistema de plasma.
- Advierta a las demás personas que se encuentren en las cercanías acerca del peligro que supone el ruido excesivo.



**UN ARCO PLASMA
PUEDE DAÑAR TUBOS
CONGELADOS**

Se puede hacer daño a los tubos congelados, o se los puede reventar, si uno trata de descongelarlos con una antorcha por plasma.



**OPERACIÓN DE
MARCAPASOS Y DE
AUDÍFONOS**

Los campos magnéticos producidos por las elevadas corrientes pueden afectar la operación de marcapasos y de audífonos. Las personas que lleven marcapasos y audífonos deberán consultar a un médico antes de acercarse a sitios donde se realizan operaciones de corte y ranurado por plasma.

Para reducir los peligros de los campos magnéticos:

- Mantenga el cable de trabajo y la manguera de la antorcha a un lado, lejos del cuerpo.
- Dirija la manguera antorcha lo más cerca posible del cable de trabajo.
- No envuelva el cable de trabajo ni la manguera de la antorcha en su cuerpo.
- Manténgase tan lejos de la fuente de energía como sea posible.

Etiqueta de advertencia

Esta etiqueta de advertencia se encuentra adherida a la fuente de energía. Es importante que el operador y el técnico de mantenimiento comprendan el sentido de estos símbolos de advertencia según se describen. El texto numerado corresponde a los cuadros numerados de la etiqueta.

WARNING	AVERTISSEMENT																												
<p>Protect yourself and others. Read and understand this marking.</p> <ul style="list-style-type: none"> Disconnect power source before servicing. Disconnect power source before disassembly of the torch. Use torches specified in the instruction manual. This plasma cutting machine must be connected to power source in accordance with applicable electrical codes. Plasma arc cutting can be injurious to operator and persons in the work area. Before operating, read and understand the manufacturer's instructions and know your employer's safety practices. 	<p>Pour votre protection et celle des autres, lire et comprendre ces consignes.</p> <ul style="list-style-type: none"> Couper l'alimentation avant d'effectuer le dépannage. Couper l'alimentation avant de démonter la torche. Utiliser exclusivement les torches indiquées dans le manuel d'instructions. Le raccordement au réseau de cette machine de coupage à arc-plasma doit être conforme aux codes de l'électricité pertinents. Le coupage à arc-plasma comporte des risques pour l'utilisateur et les personnes se trouvant dans la zone de travail. Avant le coupage, lire et comprendre les instructions du fabricant. Appliquer également les consignes de sécurité de votre entreprise. 																												
<p>Electric shock can kill.</p> <ul style="list-style-type: none"> Do not touch live electrical parts. Keep all panels and covers in place when the machine is connected to a power source. Insulate yourself from work and ground: wear insulating gloves, shoes and clothing. Keep gloves, shoes, clothing, work area, torch and this machinery dry. 	<p>Fumes and gases can injure your health.</p> <ul style="list-style-type: none"> Keep your head out of the fumes, or both to keep the fumes and gases from your breathing zone and the general area. If ventilation is inadequate, use an approved respirator. <p>WARNING: This product, when used for welding or cutting, produces fumes or gases which contain chemicals known to the state of California to cause birth defects and, in some cases, cancer.</p>																												
<p>Explosion will result if pressurized containers are cut.</p>	<p>Heat, splatter and sparks cause fire and burns.</p> <ul style="list-style-type: none"> Do not cut near combustible material. Do not cut containers that have held combustibles. Do not have on your person any combustibles such as a butane lighter or matches. 																												
<p>Arc rays can injure eyes and burn skin.</p> <ul style="list-style-type: none"> Wear correct eye and body protection. 	<p>Pilot arc can cause burns.</p> <ul style="list-style-type: none"> Keep the torch nozzle away from yourself and others when the switch is depressed. Wear correct eye and body protection. 																												
DO NOT REMOVE THIS MARKING	NE PAS ENLEVER CET AVIS																												
WARNING	AVERTISSEMENT																												
<p>INSTANT START Arc starts instantly after torch switch is depressed.</p>	<p>AMORÇAGE INSTANTANÉ L'arc s'amorce aussitôt qu'on enclenche l'interrupteur de la torche.</p>																												
<table border="1" style="width: 100%; border-collapse: collapse;"> <tr> <td style="width: 25%; text-align: center;">1 </td> <td style="width: 25%; text-align: center;">1.1 </td> <td style="width: 25%; text-align: center;">1.2 </td> <td style="width: 25%; text-align: center;">1.3 </td> </tr> <tr> <td style="text-align: center;">2 </td> <td style="text-align: center;">2.1 </td> <td style="text-align: center;">2.2 </td> <td style="text-align: center;">2.3 </td> </tr> <tr> <td style="text-align: center;">3 </td> <td style="text-align: center;">3.1 </td> <td style="text-align: center;">3.2 </td> <td style="text-align: center;">3.3 </td> </tr> </table>	1 	1.1 	1.2 	1.3 	2 	2.1 	2.2 	2.3 	3 	3.1 	3.2 	3.3 	<table border="1" style="width: 100%; border-collapse: collapse;"> <tr> <td style="width: 25%; text-align: center;">4 </td> <td style="width: 25%; text-align: center;">4.1 </td> <td style="width: 25%; text-align: center;">4.2 </td> <td style="width: 25%; text-align: center;">4.3 </td> </tr> <tr> <td style="text-align: center;">5 </td> <td style="text-align: center;">5.1 </td> <td colspan="2" style="text-align: center;">+ + + </td> </tr> <tr> <td style="text-align: center;">6 </td> <td colspan="3" style="text-align: center;">+ + + </td> </tr> <tr> <td style="text-align: center;">7 </td> <td colspan="3" style="text-align: center;">+ + + </td> </tr> </table>	4 	4.1 	4.2 	4.3 	5 	5.1 	+ + + 		6 	+ + + 			7 	+ + + 		
1 	1.1 	1.2 	1.3 																										
2 	2.1 	2.2 	2.3 																										
3 	3.1 	3.2 	3.3 																										
4 	4.1 	4.2 	4.3 																										
5 	5.1 	+ + + 																											
6 	+ + + 																												
7 	+ + + 																												

1. Las chispas producidas por el corte pueden causar explosiones o incendios.
 - 1.1 Mantenga los materiales inflamables lejos del lugar de corte.
 - 1.2 Tenga a mano un extinguidor de incendios y asegúrese de que alguien esté preparado para utilizarlo.
 - 1.3 No corte depósitos cerrados.
2. El arco de plasma puede causar quemaduras y lesiones.
 - 2.1 Apague la fuente de energía antes de desarmar la antorcha.
 - 2.2 No sostenga el material junto al trayecto de corte.
 - 2.3 Proteja su cuerpo completamente.
3. Los electrochoques provocados por la antorcha o el cableado pueden ser fatales. Protéjase del electrochoque.
 - 3.1 Colóquese guantes aislantes. No utilice guantes dañados o mojados.
 - 3.2 Aíslese de la pieza de trabajo y de la tierra.
 - 3.3 Antes de trabajar en una máquina, desconecte el enchufe de entrada o la potencia primaria.
4. La inhalación de los humos provenientes del área de corte puede ser nociva para la salud.
 - 4.1 Mantenga la cabeza fuera de los gases tóxicos.
 - 4.2 Utilice ventilación forzada o un sistema local de escape para eliminar los humos.
 - 4.3 Utilice un ventilador para eliminar los humos.
5. Los rayos del arco pueden producir quemaduras en los ojos y en la piel.
 - 5.1 Utilice un sombrero y gafas de seguridad. Utilice protección para los oídos y abróchese el botón del cuello de la camisa. Utilice un casco de soldar con el filtro de sombreado adecuado. Proteja su cuerpo completamente.
6. Antes de trabajar en la máquina o de proceder a cortar, capacítase y lea las instrucciones completamente.
7. No retire las etiquetas de advertencia ni las cubra con pintura.

Section 2

SPECIFICATIONS

In this section:

Power supply	2-2
Dimensions and weight.....	2-3
T80 Torches	2-4
Dimensions.....	2-5
Symbols and markings.....	2-6
[S] mark	2-6
CE mark.....	2-6
IEC symbols used.....	2-6

SPECIFICATIONS

Power supply

Rated open circuit voltage (U_0)	300 VDC		
OutputCharacteristic* *Defined as a plot of output voltage versus output current	Drooping		
Rated output current (I_2)	25A – 80A		
Hypertherm standard rated output voltage (U_2)	150 VDC		
Duty cycle (X^*) at 104°F (40°C) at rated conditions (U_1, I_1, U_2, I_2)	U_1 – Volts AC rms	X	
	200-208 VAC 1PH	40%	
	230-240 VAC 1PH	50%	
	480 VAC 1PH	60%	
	200-208 VAC 3PH	50%	
	230-240 VAC 3PH	60%	
	380-400-415 VAC 3PH	60%	
	480 VAC 3PH	60%	
	600 VAC 3PH	60%	
* $X = T_{on}/T_{base}$, T_{on} = time, minutes T_{base} = 10 minutes (See the data plate on the power supply for more information on duty cycle and for IEC ratings.)			
Operating temperature	14° to 104° F (-10° to 40° C)		
Rated AC phases (PH) and line frequency (Hz)	PH	Hz	
Standard model	1-3	50-60	
CE model	3	50-60	
Rated input voltage (U_1), rated input current (I_1) and I_{1eff}^* at rated output U_2 and I_2 – cutting only.	U_1 – Volts AC rms	I_1 -Amps rms	I_{1eff}
	200-208 VAC 1PH	70	44
	230-240 VAC 1PH	60	42
	480 VAC 1PH	30	23
	200-208 VAC 3PH	40	28
	230-240 VAC 3PH	36	28
	380-400-415 VAC 3PH	21	16
	480 VAC 3PH	17	13
	600 VAC 3PH	16.5	13
* $I_{1eff} = (I_1)\sqrt{X}$ used to determine rating of power cord.			
Power factor	U_1 – Volts AC rms	Harmonic power factor	Displacement power factor
	200-208 VAC 1PH	0.99	0.99
	230-240 VAC 1PH	0.99	0.99
	480 VAC 1PH	0.91	0.99
	200-208 VAC 3PH	0.94	0.99
	230-240 VAC 3PH	0.94	0.99
	380-400-415 VAC 3PH	0.94	0.99
	480 VAC 3PH	0.94	0.99
	600 VAC 3PH	0.80	0.99
R_{scc} – short circuit ratio—CE model only	U_1 – Volts AC rms, 3PH	R_{scc}	
	400 VAC	228	
	230 VAC	163	
	<i>This equipment conforms to IEC 61000-3-12, provided that $R_{scc\ min} = 228$ at 400VAC 3PH and 163 at 230 VAC 3PH.</i>		
IP code—degree of protection provided by enclosure	IP23CS* IP – “International Protection” 2 – No ingress foreign objects ≥ 12.5 mm (0.5 in) 3 – No harmful ingress spraying water C – AC line circuits protected against ingress of tool ≥ 2.5 mm dia. x 100 mm long (0.1 inch x 4.0 inch) S – fan stationary during water test *WARNING: DO NOT OPERATE IN RAIN		
Toppling, tilting (with or without wheel kit)	Up to 15° incline.		
Gas type	Air	Nitrogen	
Gas quality	Clean, moisture-free, oil-free		
Gas inlet pressure and flow	See Section 3, Setup		

Dimensions and weight

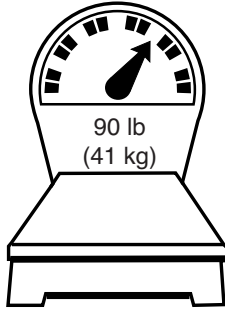

Weight of the power supply
without a torch

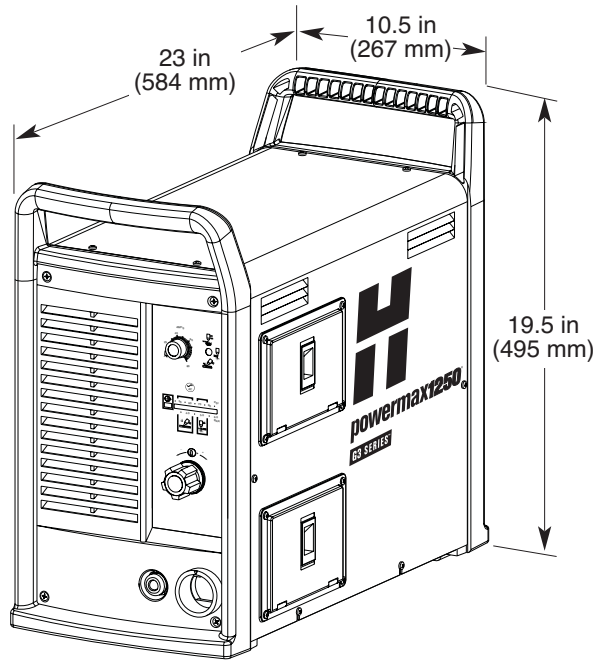

T80 torches

Handheld cutting capacity at 80 amps	
Recommended capacity	7/8 inch (22 mm)
Maximum capacity	1-1/8 inch (29 mm)
Severance capacity	1-1/2 inch (38 mm)
Mechanized cutting capacity at 80 amps	
Recommended capacity	3/8 inch (10 mm)
Maximum capacity	5/8 inch (16 mm)
Gouging Capability (metal removal rate on mild steel)	12.2 pounds (5.5 kg) / hour
Weight	
T80	7.2 pounds (3.3 kg) with 25 ft (7.5 m) lead 13.9 pounds (6.3 kg) with 50 ft (15 m) lead 20.6 pounds (9.4 kg) with 75 ft (22.5 m) lead
T80M	4.5 pounds (2.0 kg) with 15 ft (4.5 m) lead 8.3 pounds (3.8 kg) with 25 ft (7.5 m) lead 9.9 pounds (4.5 kg) with 35 ft (10.7 m) lead 15.0 pounds (6.8 kg) with 50 ft (15 m) lead 21.7 pounds (9.9 kg) with 75 ft (22.5 m) lead

Torch dimensions

T80 dimensions

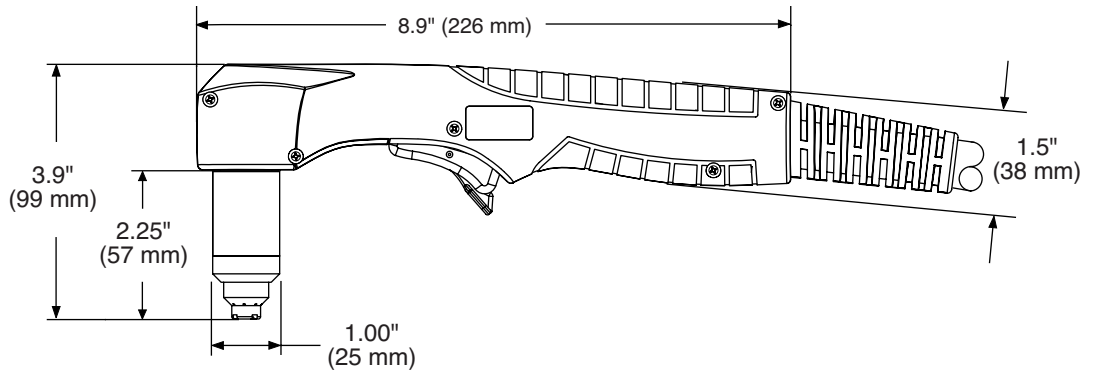

T80M dimensions

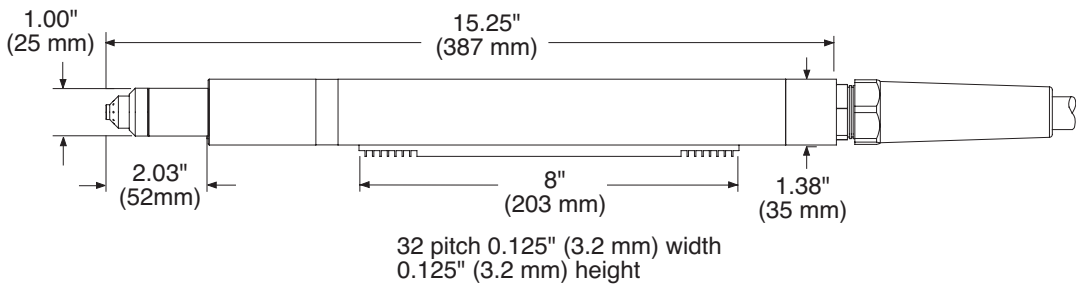

Symbols and Markings

S mark











The **S** mark indicates that the power supply and torch are suitable for use in environments with increased hazard of electrical shock. The hand torches must have shielded consumable parts to maintain **S** mark compliance.

CE mark

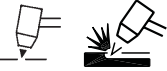
The CE mark (**C** **E**) constitutes a manufacturer's declaration of conformity to applicable European directives and standards. Only those versions of Hypertherm products with a CE mark located on or near the data plate have been tested for compliance with the European Low Voltage Directive and the European EMC Directive. EMC filters needed to comply with the European EMC Directive are incorporated within versions of the power supply with a CE mark.

IEC symbols used

The following symbols may appear on the power supply data plate, control labels and switches.

	Direct Current (DC)		An inverter-based power source
	Alternating current (AC)		Plasma torch in the TEST position (cooling and cutting gas exiting nozzle)
	Plasma torch cutting and gouging		Power is on
	AC input power connection		Power is off
	The terminal for the external protective (earth) conductor		Volt/amp curve, "drooping" characteristic

Section 3

SETUP

In this section:

Upon receipt	3-2
Claims	3-2
Contents of box	3-2
Locating the power supply.....	3-3
Lifting the power supply.....	3-3
Power connection	3-4
Three-phase power cord – plug installation	3-4
Single-phase power cord.....	3-5
Power cord installation.....	3-5
Plug installation.....	3-5
Grounding	3-6
Extension cords.....	3-6
Torch installation.....	3-7
Plasma gas supply	3-9
Additional gas filtration.....	3-9
Gas supply installation	3-10
T80M torch alignment.....	3-10
ON/OFF pendant connection	3-11
Machine interface connection	3-11
Arc voltage.....	3-12
Changing XFER (start machine motion) from dry contact closure to voltage signal.....	3-14
Driving an industrial isolated input module	3-15
Driving a relay coil with an external power source.....	3-16
Driving an industrial isolated input module with an external power source	3-17

Upon receipt

1. Check that all items on your order have been received. Contact your distributor or OEM if any items are missing or damaged.
2. If there is evidence of damage, refer to *Claims*, below. All communications regarding this equipment must include the model number and serial number located on the back of the power supply.
3. Read Section 1, *Safety*, before setting up and operating this Hypertherm system.

Claims

Claims for damage during shipment: If your unit was damaged during shipment, you must file a claim with the carrier. Hypertherm will furnish you with a copy of the bill of lading upon request. If you need additional assistance, call the nearest Hypertherm office listed in the front of this manual.

Claims for defective or missing merchandise: If any component is missing or defective, contact your Hypertherm distributor/OEM. If you need additional assistance, call the nearest Hypertherm office listed in the front of this manual.

Contents of box

Verify items against the illustration shown (for hand system configurations).

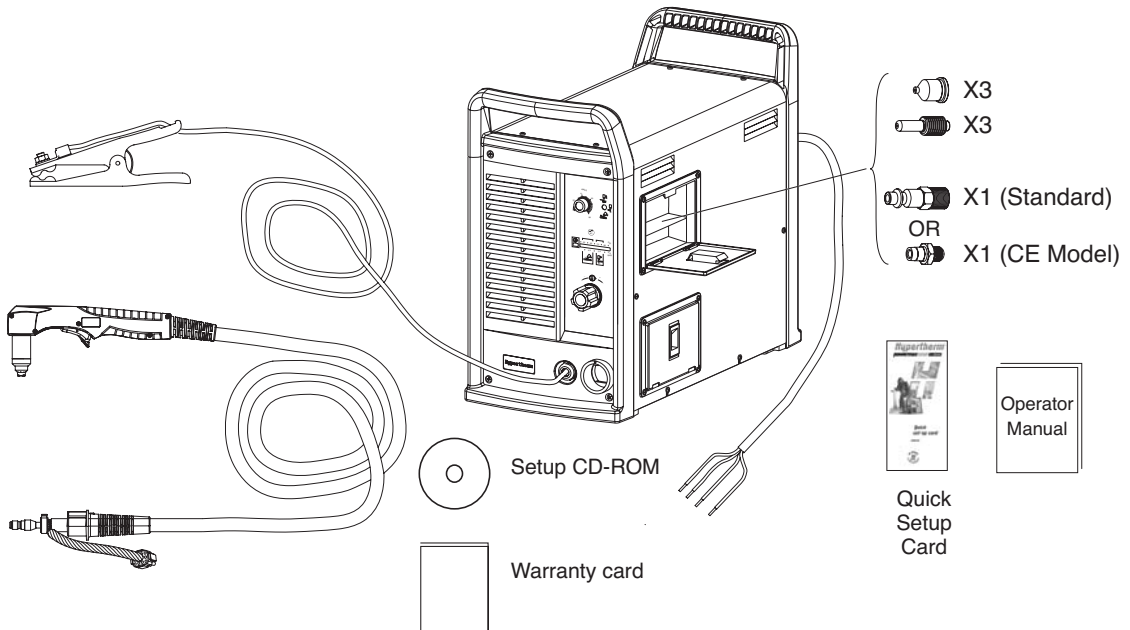

Locating the power supply

Locate the Powermax1250 power supply with at least 10 inches (0.25 m) of open space at the front and back and fan side of the power supply for proper ventilation.

Lifting the power supply

		WARNING
<ul style="list-style-type: none"> • The system weighs up to 112 lb / 51 kg. • Always lift the power supply by TWO handles. • Do not lift the power supply by ONE handle. • The handle can break, resulting in injury and damage. 		

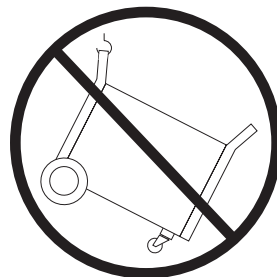
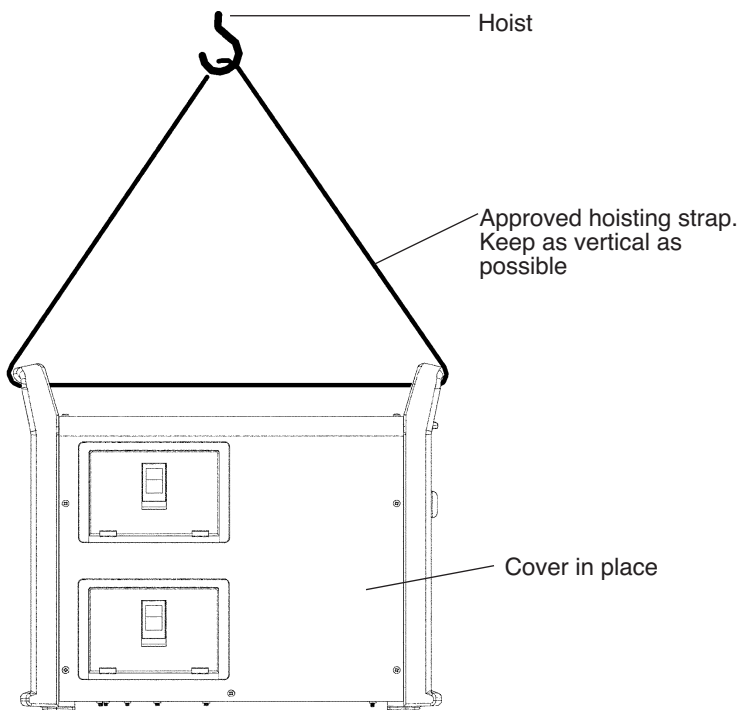

Power connection

The Powermax1250 is a universal power supply that can configure itself to operate with AC voltages from 200 to 600 (230-400 3PH for CE model). Use a line disconnect switch for each power supply so that the operator can turn off the power supply quickly in an emergency. Locate the switch so it is easily accessible to the operator. The interrupt level of the switch must be equal to or exceed the continuous rating of the fuses. Use slow-blow fuses rated per local and national electrical codes.

Standard Model	Single Phase			Three Phase				
	200-208	230-240	480	200-208	230-240	400	480	600
Input Voltage	200-208	230-240	480	200-208	230-240	400	480	600
Input Current at 12kw Output	70	60	30	40	36	21	17	16.5
Input Current during Arc Stretch	100	96	48	56	56	34	28	27

CE Model	Three Phase	
Input Voltage	230	400
Input Current at 12kw Output	36	21
Input Current during Arc Stretch	56	34

Three-phase power cord – plug installation

The Powermax1250 power supplies are shipped with an 8 AWG 4-wire power cord on standard models. A 6 mm², 4-wire HAR power cord is provided on CE models. To operate the Powermax1250, use a plug that meets national or local electrical codes. The plug must be connected to the power cord by a licensed electrician.

Single-phase power cord (not for CE model)

CAUTION: When using the standard model power supply (CE model is 3PH only) with a single-phase power source, replace the supplied power cord with a 6 AWG (16mm²) 3-wire power cord. The power cord must be connected by a licensed electrician.

Power cord installation

Strip and prepare the power cord wires as shown below:

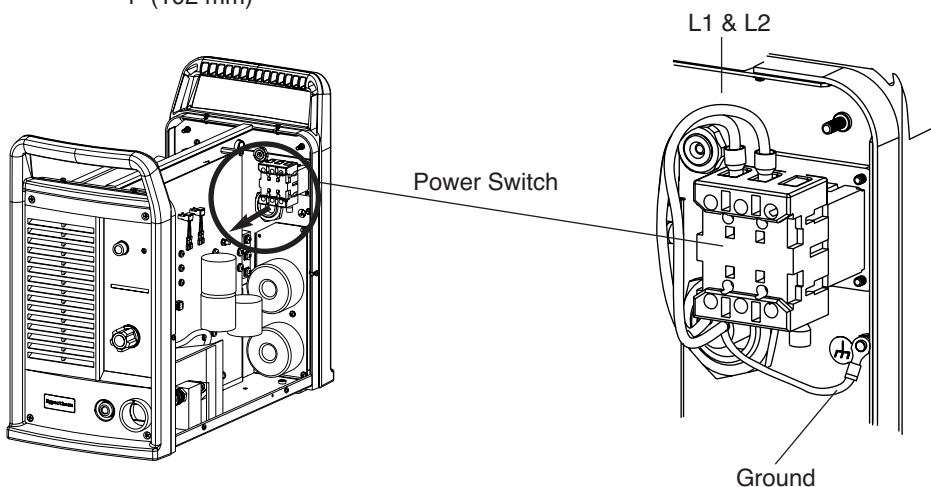
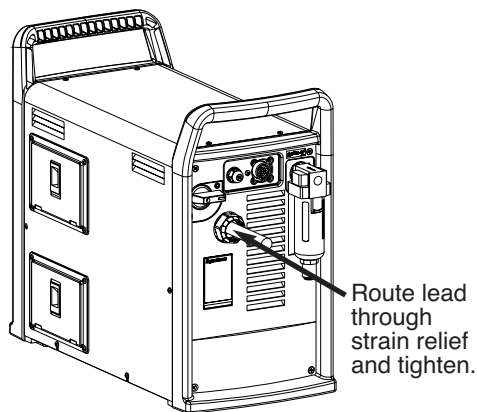
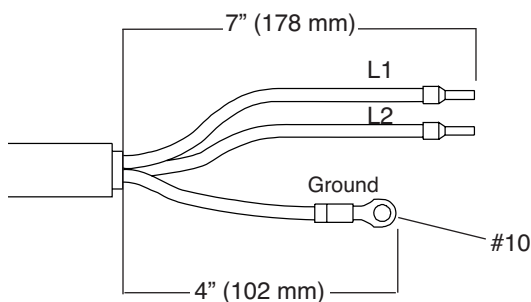

Plug installation

The plug must be connected to the power cord by a licensed electrician.

Grounding

To ensure personal safety and proper operation, and to reduce electromagnetic interference (EMI), the Powermax1250 must be properly grounded through the power cord according to national or local electrical codes. Three-phase service must be of the 4-wire type with a green or green/yellow wire for protective earth ground and must comply with national or local electrical requirements. Single-phase service must be of the 3-wire type with a green or green/yellow wire for protective earth ground and must comply with national or local electrical requirements. Refer to Section 1, *Grounding safety*.

Extension Cords

Use a cord that is certified by national or local codes. The cord should be installed by a licensed electrician. Refer to the length requirements listed below.

		Recommended extension cord gauge size AWG (mm ²)									
		< 10 ft < 3 m		10-25 ft 3 – 7.5 m		25-50 ft 7.5 – 15 m		50-100 ft 15 – 30 m		100-150 ft 30 – 45 m	
Standard model											
Input-voltage	Phase	AWG	mm²	AWG	mm²	AWG	mm²	AWG	mm²	AWG	mm²
200-208 VAC	1	6	(16)	6	(16)	6	(16)	4	(25)	2	(35)
230 VAC	1	6	(16)	6	(16)	6	(16)	4	(25)	2	(35)
480 VAC	1	10	(6)	10	(6)	10	(6)	8	(10)	8	(10)
200-208 VAC	3	8	(10)	8	(10)	8	(10)	6	(16)	6	(16)
230 VAC	3	8	(10)	8	(10)	8	(10)	6	(16)	6	(16)
400 VAC	3	10	(6)	10	(6)	10	(6)	10	(6)	8	(10)
480 VAC	3	10	(6)	10	(6)	10	(6)	10	(6)	8	(10)
600 VAC	3	10	(6)	10	(6)	10	(6)	10	(6)	10	(6)
CE model	Phase	mm²		mm²		mm²		mm²		mm²	
230 VAC	3	(6)		(6)		(10)		(10)		(10)	
400 VAC	3	(6)		(6)		(6)		(6)		(10)	

Torch installation

- ① Turn OFF power.

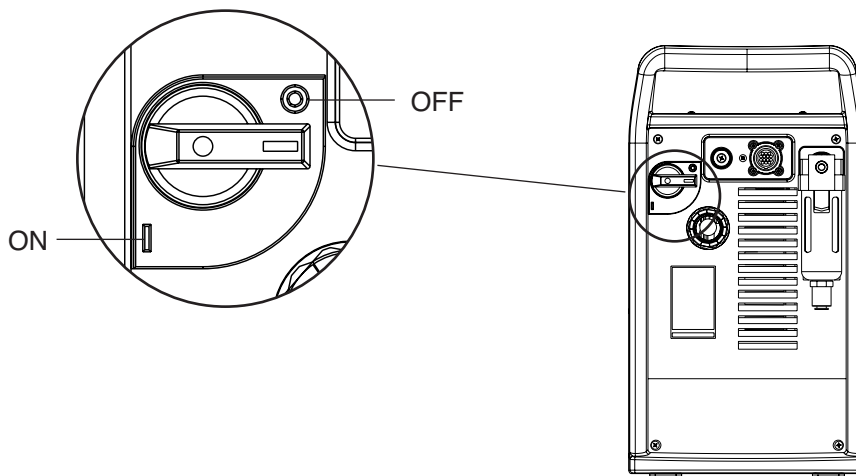

- ② Remove the power cord from the power receptacle.

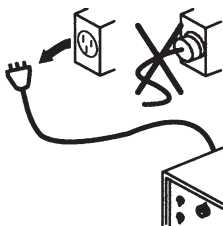

- ③ Open the ETR door and route the lead through the end cap.

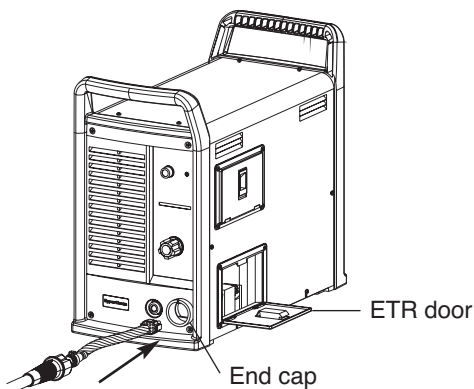

- ④ Align the marks on the strain relief.

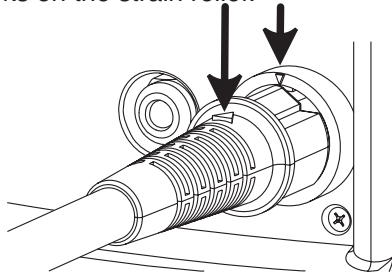

- ⑤ Pull back the quick release collar and insert the lead's gas fitting.

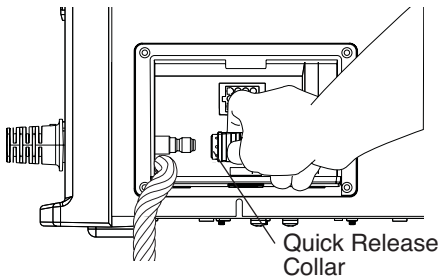

- ⑥ Slide the quick release collar forward to lock in the gas fitting. Make sure that the gas fitting is secure.

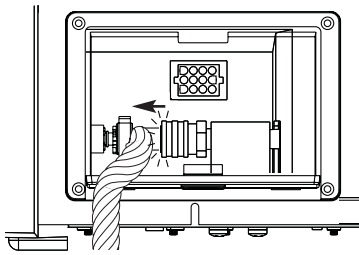

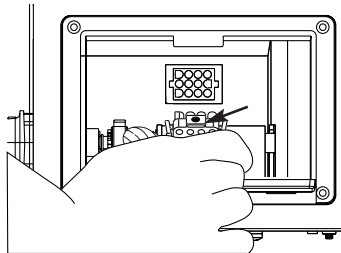

- ⑦ Make sure that the red dot on the connector is on top, then plug in the electrical connector. Close the ETR door.



Plasma gas supply

The gas supply for the Powermax1250 can be shop compressed air or cylinder compressed air. A high-pressure regulator must be used on either type of supply and must be capable of delivering gas to the filter on the power supply at **400 scfh/6.7 scfm (189 l/min)**, minimum flow rate, at a minimum pressure of **90 psig (6.1 bar)**. If gas supply quality is poor, cut speeds decrease, cut quality deteriorates, cutting thickness capability decreases, and parts life shortens.

		WARNING
Do not allow the air inlet pressure to the filter on the power supply to exceed 120 psi (8.3 bar). The filter bowl may explode if this pressure is exceeded.		

Additional gas filtration

Use Hypertherm filter kit, part number 128647, when site conditions introduce moisture, oil or other particulates into the air line. A 3-stage coalescing filtration system, as shown, can also be used.

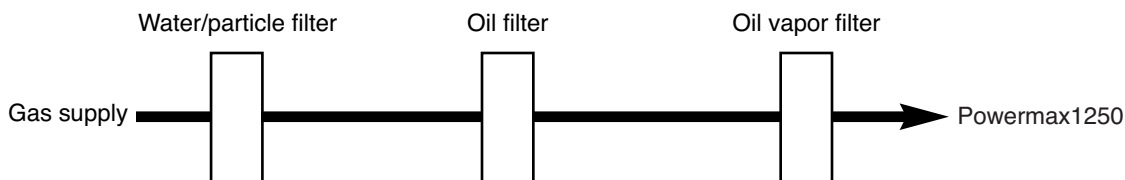

Gas supply installation

Connect the air hose as follows:

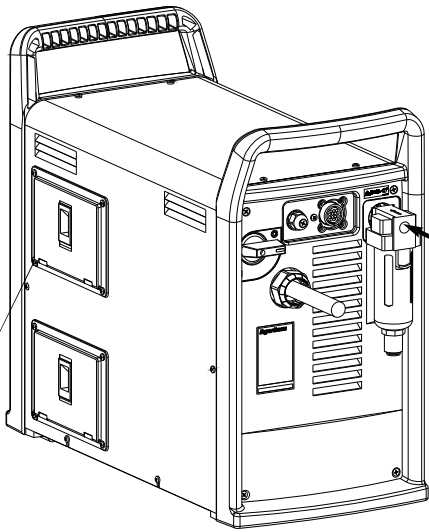

1. Air fitting

- Standard model: Install a 1/4 NPT gas fitting on the air filter inlet. CE model: Use a G1/4 adapter (supplied). Use liquid pipe sealant on threads.

Caution: Never use PTFE tape when installing the nipple or adapters. Bits of tape can break off and enter the air line and harm the pressure regulator, pressure switch and valve.

- The nipple and adapter are in the consumables box, located on the left side of the power supply cover.

2. Air hose

- Use an inert gas hose with a 3/8 inch (9.5 mm) internal diameter. Connect it to the gas fitting installed in step 1.

Adjust the air pressure according to the procedure in Section 4, *Operation*.

T80M torch alignment

Mount the machine torch perpendicular to the workpiece in order to get a vertical cut. Use a square to align the torch at 0° and 90°.

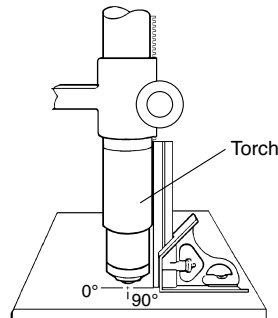

ON/OFF pendant connection

For the machine torch (T80M), inputs for arc start are available through the machine interface connection on the rear of the power supply. Plug the Hypertherm remote pendant (see *Accessories* in Section 5, *Maintenance and parts*, for part numbers) into the connector on the rear panel.



WARNING

The ON/OFF remote pendant will not operate when a hand torch is installed.

Machine interface connection



Signals for arc transfer and start are available through the machine interface connection on the rear of the power supply. Plug the machine interface cable (part number 023206) into the connector on the rear panel.

Powermax1250 power supplies sold as part of the PowermaxEdge® package include a machine interface cable with a voltage divider.

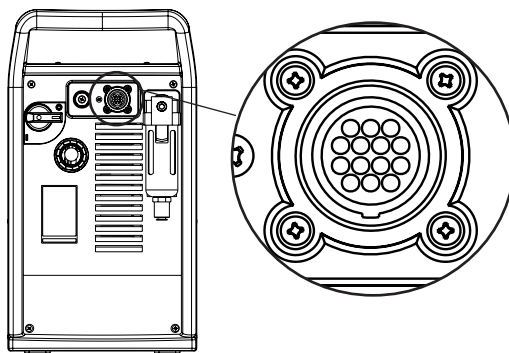
Refer to the following table when connecting the machine interface cable to the cutting machine.

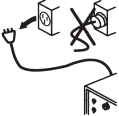

Signal	Start (start plasma)	XFER (start machine motion)	PowermaxEdge (Interface cable with voltage divider)
Type:	Input	Output	Output
Notes:	Normally open. 18VDC open circuit voltage at START terminals. Requires dry contact closure to activate.	Normally open. Dry contact closure when arc transfers. 120VAC/1A maximum at machine interface relay or switching device (supplied by customer).	Divided arc signal of 50:1
Rear panel sockets	3, 4	12, 14	5, 6
Cable wires	Green, black	Red, black	Black, red

		WARNING ELECTRIC SHOCK CAN KILL
		Disconnect electrical power before performing any maintenance. All work requiring removal of the power supply cover must be performed by a qualified technician.

Arc voltage

For systems other than the PowermaxEdge bundle, you can use arc voltage from the power supply to activate a torch height control. To do so, you must supply an 18 AWG (1.0 mm²), single pair, unshielded cable rated for 300V or greater. All work must be performed following applicable national or local codes.

- 1. Disconnect power from the power supply.
- 2. Remove screws that attach the power supply cover to the chassis. Remove the cover.
- 3. Feed the cable through the strain relief, shown below, at the rear of the power supply.

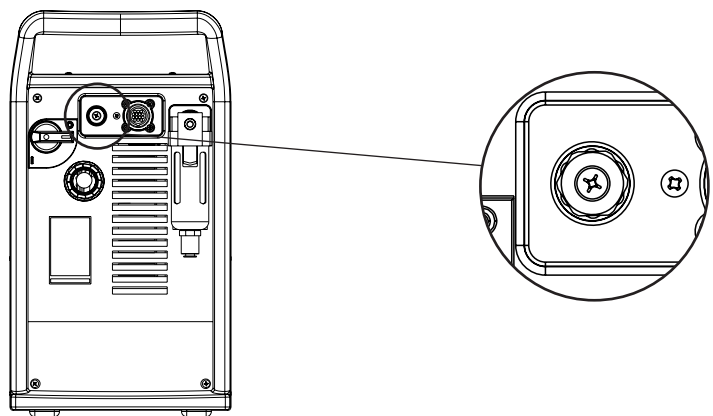

- Find the power board, as shown below. Use insulated type 1/4" faston terminal ends to connect to J15 and J16.

Note: 120VAC or 24 VAC must be sourced externally.

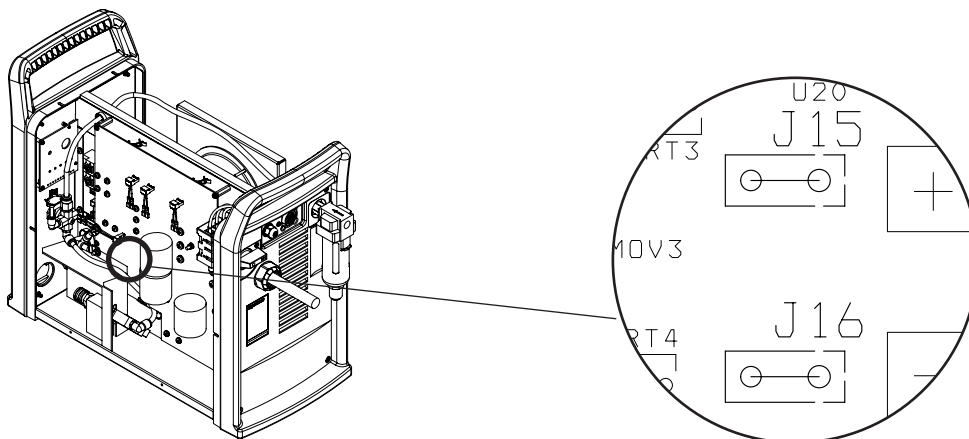

Signal:	Arc voltage (torch height control)
Type:	Output
Notes:	Full arc voltage. No voltage divider. 300VDC maximum. (Signal not available on rear panel connector.)
J15	+VDC
J16	-VDC

- Tighten the strain relief.
- Replace the cover

Changing XFER (start machine motion) from dry contact closure to voltage signal

24 VDC (chassis ground reference) at 100ma max is available at J19 on the power board to drive an isolated/floating device such as a 24 VDC relay coil (240 ohms or greater) or a typical industrial input isolation module (which has an opto-coupler built-in). Shown below are typical connections for a high side drive arrangement.

Driving a Relay Coil

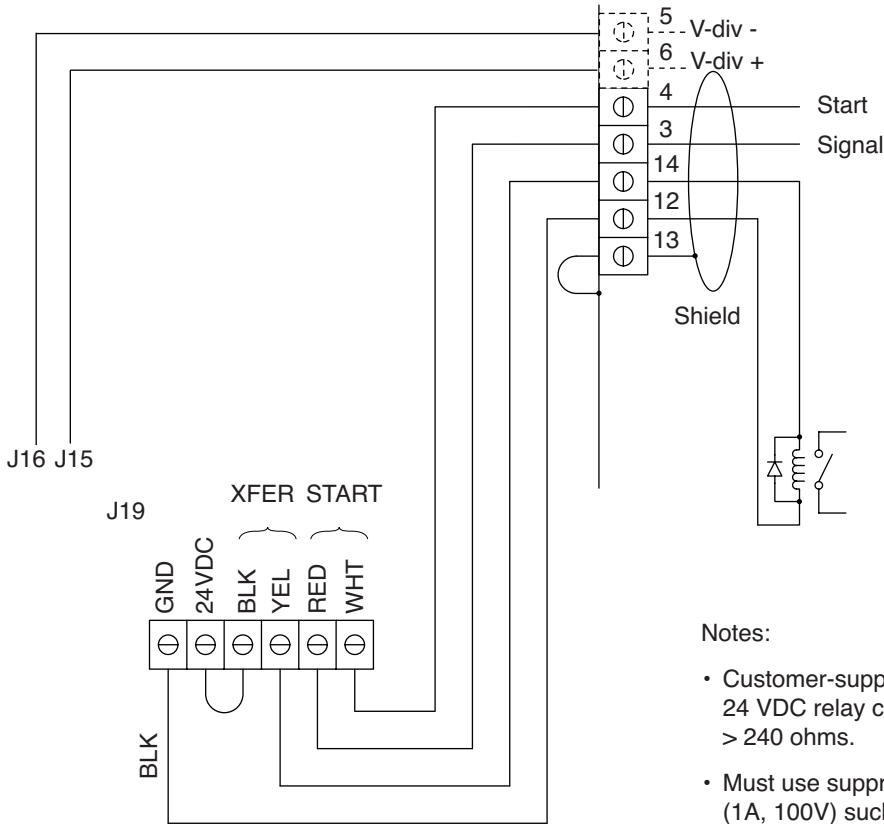

Move black (BLK) wire to ground (GND) and add jumper wire as shown.

Notes:

- Customer-supplied 24 VDC relay coil > 240 ohms.
- Must use suppression diode (1A, 100V) such as IN4002 through IN4004 type across coil.
- Pins 5 and 6 are used only on systems that include the PowermaxEdge cable with voltage divider.

Driving an industrial isolated input module

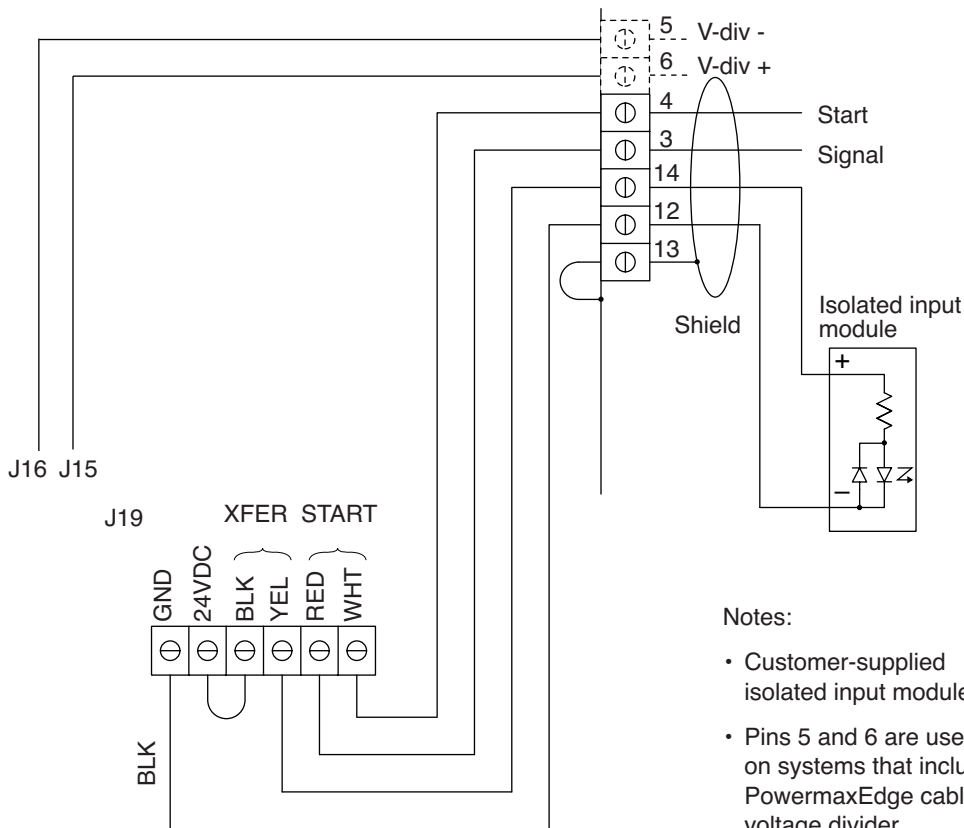

- Notes:
- Customer-supplied isolated input module.
 - Pins 5 and 6 are used only on systems that include the PowermaxEdge cable with voltage divider.

Move black (BLK) wire to ground (GND) and add jumper wire as shown.

Driving a relay coil with an external power source

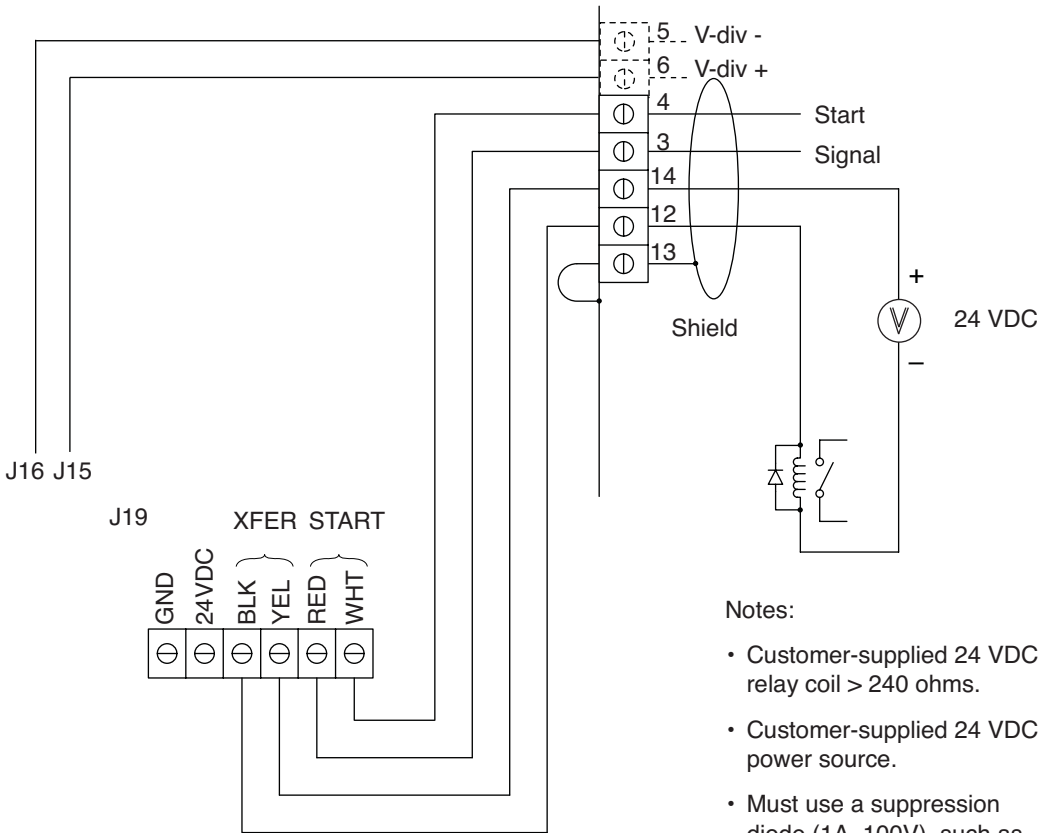

- Notes:
- Customer-supplied 24 VDC relay coil > 240 ohms.
 - Customer-supplied 24 VDC power source.
 - Must use a suppression diode (1A, 100V), such as IN4002 through IN4004 type, across the coil.
 - Pins 5 and 6 are used only on systems that include the PowermaxEdge cable with voltage divider.

Driving an industrial isolated input module with an external power source

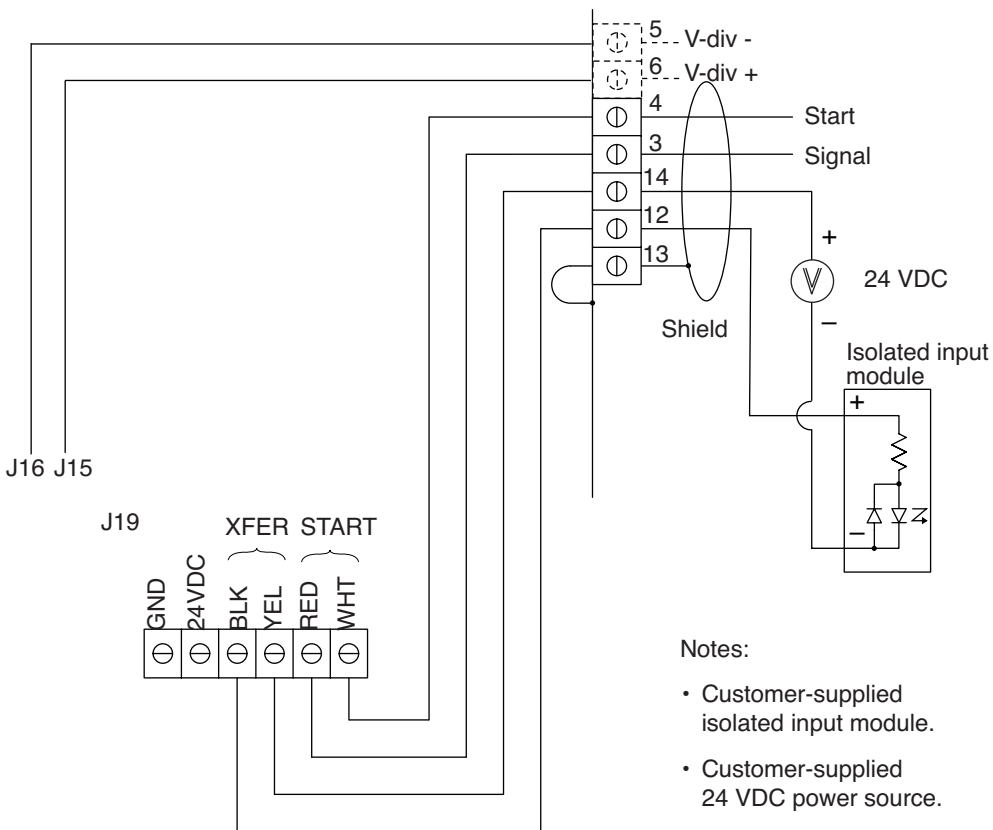

Notes:

- Customer-supplied isolated input module.
- Customer-supplied 24 VDC power source.
- Pins 5 and 6 are used only on systems that include the PowermaxEdge cable with voltage divider.

Section 4

OPERATION

In this section:

Controls and indicators.....	4-3
Indicator LEDs	4-3
T80 consumable configurations	4-4
Shielded	4-4
FineCut	4-4
Gouging	4-5
T80M consumable configurations	4-5
Shielded.....	4-5
FineCut	4-6
Ohmic sensing retaining cap	4-6
Unshielded.....	4-6
Install the torch consumables	4-7
Set the mode switch	4-8
Set the power switch to ON	4-8
Check the indicator lights	4-8
Adjust the gas pressure and current setting	4-9
Hand torch operation.....	4-10
Safety trigger operation	4-10
Attach the work clamp.....	4-11
Starting a cut from the edge of the workpiece	4-11
Hand torch cutting technique	4-12
Piercing	4-13
Gouging	4-14

OPERATION

Cut charts	4-15
80 amp mechanized shielded consumables	4-15
60 amp mechanized shielded consumables	4-16
40 amp mechanized shielded consumables	4-17
FineCut consumables	4-18
40 amp mechanized unshielded consumables	4-19

Controls and indicators

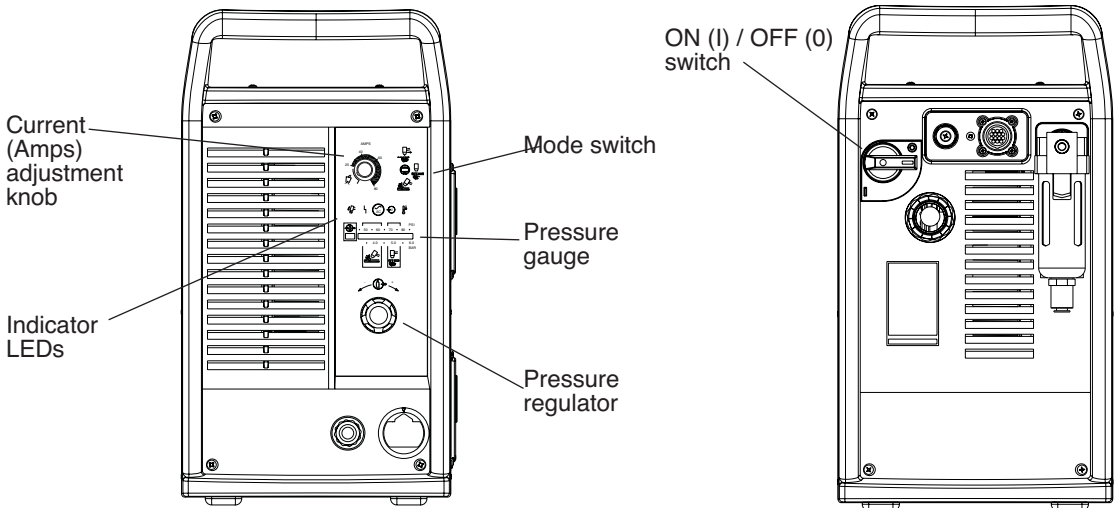

Indicator LEDs



Green power ON LED

When illuminated, indicates that power is applied to system and power switch is ON (I).



Gas pressure LED

Yellow: When flashing, indicates that the gas pressure is below 60 psig (4.1 bar) for cutting, or 40 psig (2.8 bar) for gouging.

Green: When illuminated, it indicates that there is acceptable gas pressure for torch operation.



Yellow torch cap LED

When illuminated, indicates that the retaining cap is loose or not installed.

Note: The condition must be corrected and power turned OFF and then ON again to clear LED.



Yellow temperature LED

When illuminated, indicates that the power supply temperature has exceeded its operating limit.



Red fault LED

When illuminated, indicates that a fault condition exists, which prevents system operation.



Yellow low line voltage LED

When illuminated, indicates that line voltage is below 170 VAC or above 680 VAC. On CE units, it can also indicate a missing phase.

T80 consumable configurations

Shielded

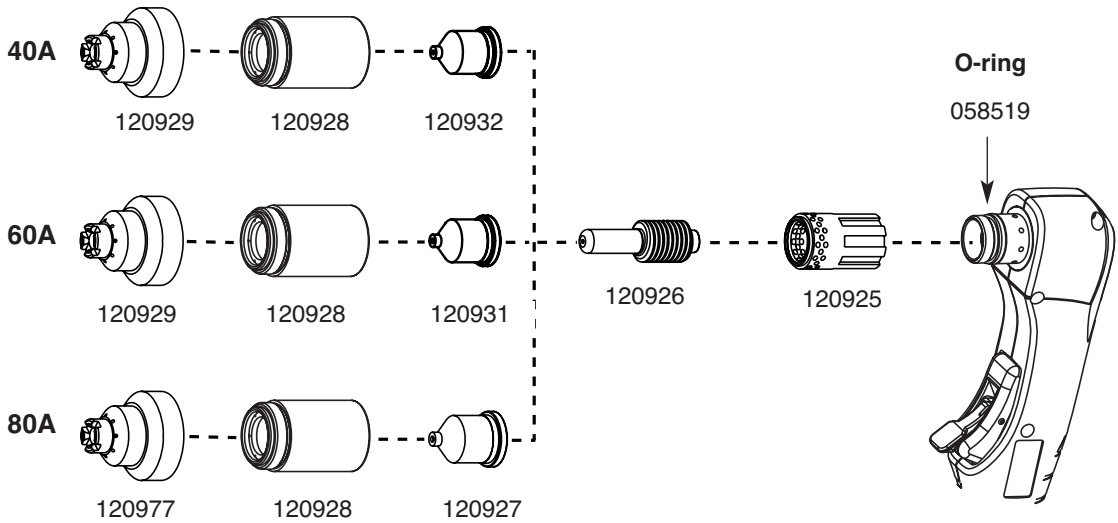

FineCut

30A — 50A

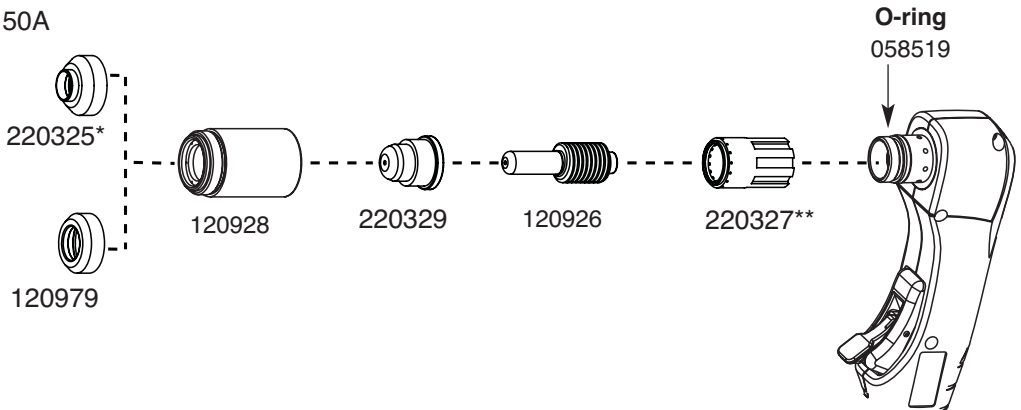

*For use with CE systems.

**The 22037 swirl ring is intended for manual cutting with FineCut consumables.

Gouging

60A/80A

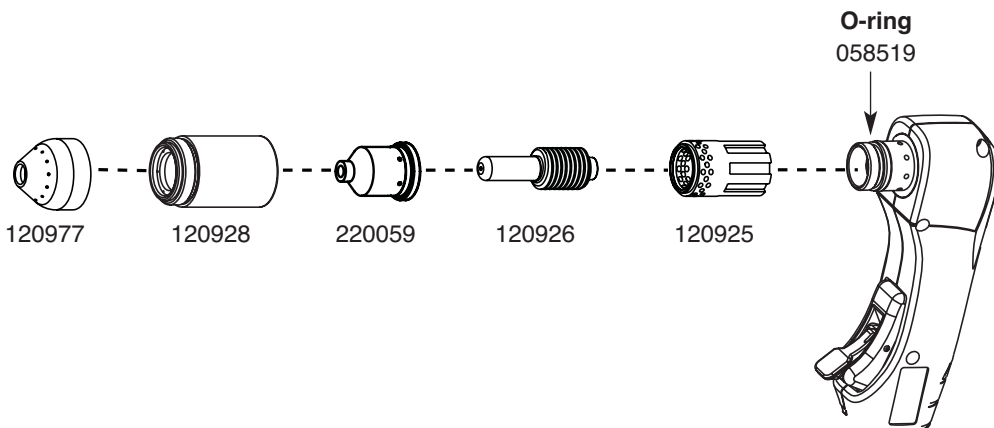

T80M consumable configurations

Shielded

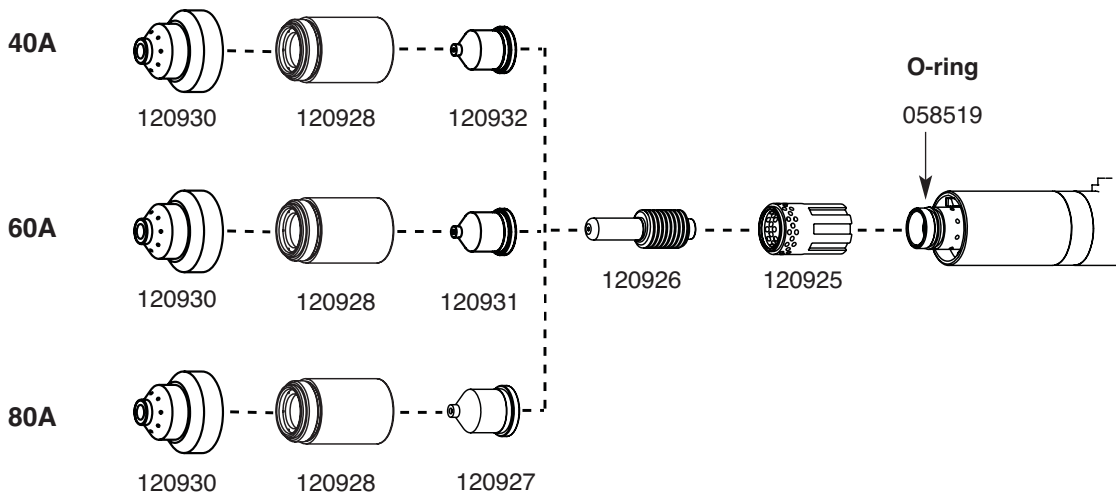

OPERATION

FineCut

30A – 50A

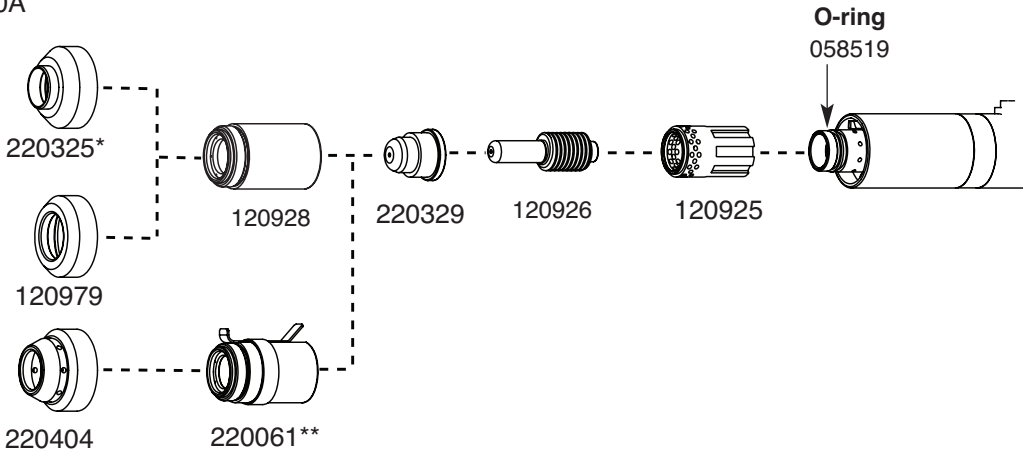

Ohmic sensing retaining cap

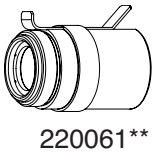

* In CE countries, unshielded consumables may only be used in mechanized torch applications.

** Use an ohmic sensing cap when a compatible torch height controller is installed.

Unshielded*

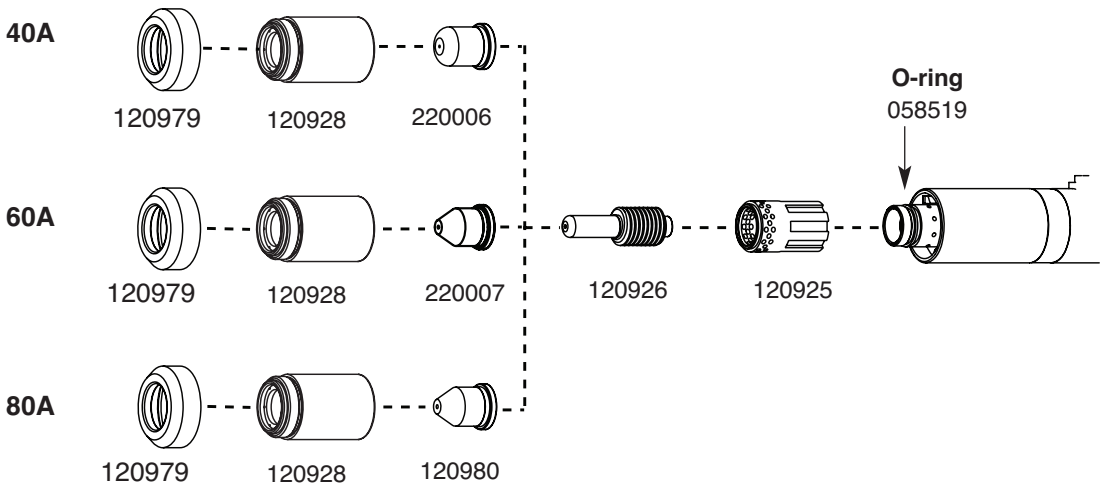

Install the torch consumables

		WARNING INSTANT-ON TORCHES PLASMA ARC CAN CAUSE INJURY AND BURNS
	Plasma arc comes on immediately when the torch switch is activated. The plasma arc will quickly burn through gloves and skin. Make sure power is OFF before changing consumables.	

①

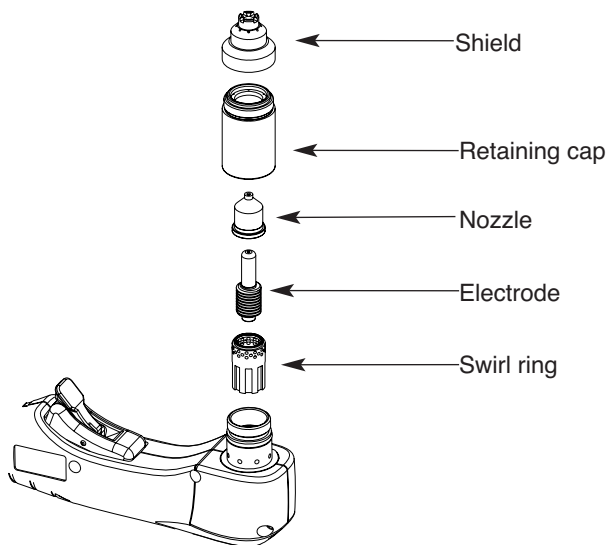

②

Hand tighten only.

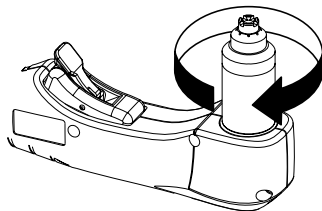

Set the mode switch

①

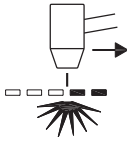

Use to cut expanded metal.
Automatically reinitiates pilot.



Use to cut plate/sheet metal.
Optimum consumable life.



Use to gouge, or for non-transferred-arc operation.

Set the power switch to ON

②

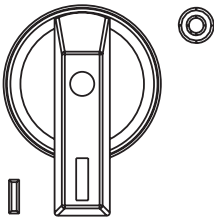

Position the power switch to ON (I) as shown.

Check the indicator lights

③



Check that the POWER ON lamp is illuminated.



Check that the gas pressure LED is illuminated in green.

Check that the remaining indicator lamps are NOT illuminated. See Section 5, *Maintenance and parts*, for details.



Adjust the gas pressure and current setting

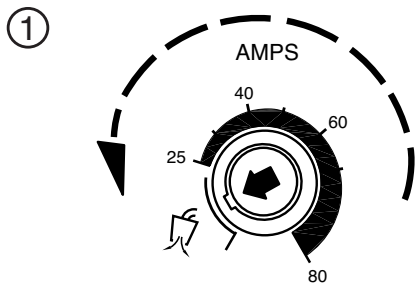

Set the current knob to gas test.

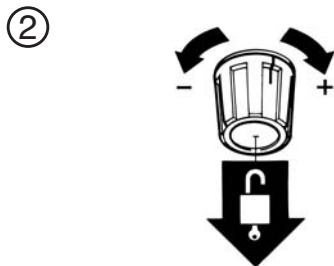

Pull the regulator knob to unlock.

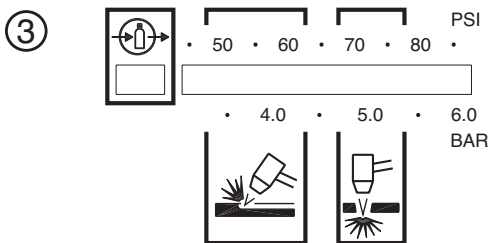

Set the pressure:

Cutting 70–75 psig (4.8–5.2 bar)

Gouging 50–60 psig (3.4–4.1 bar)

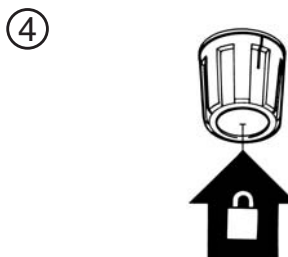

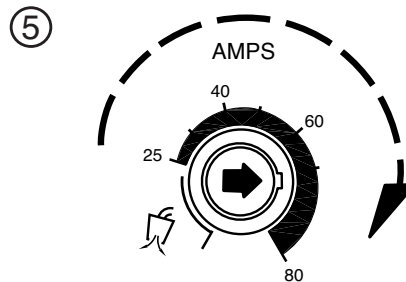

Push the regulator knob to lock.



Turn the current knob away from gas test to stop the gas flow (25 amps minimum).

Hand torch operation

		WARNING INSTANT-ON TORCHES PLASMA ARC CAN CAUSE INJURY AND BURNS
<p>Plasma arc comes on immediately when the torch switch is activated. The plasma arc will quickly burn through gloves and skin.</p> <ul style="list-style-type: none">• Keep away from the torch tip.• Do not hold the workpiece, and keep your hands clear of the cutting path.• Never point the torch toward yourself or others.• Never use with Pendant Switch.		

Safety trigger operation

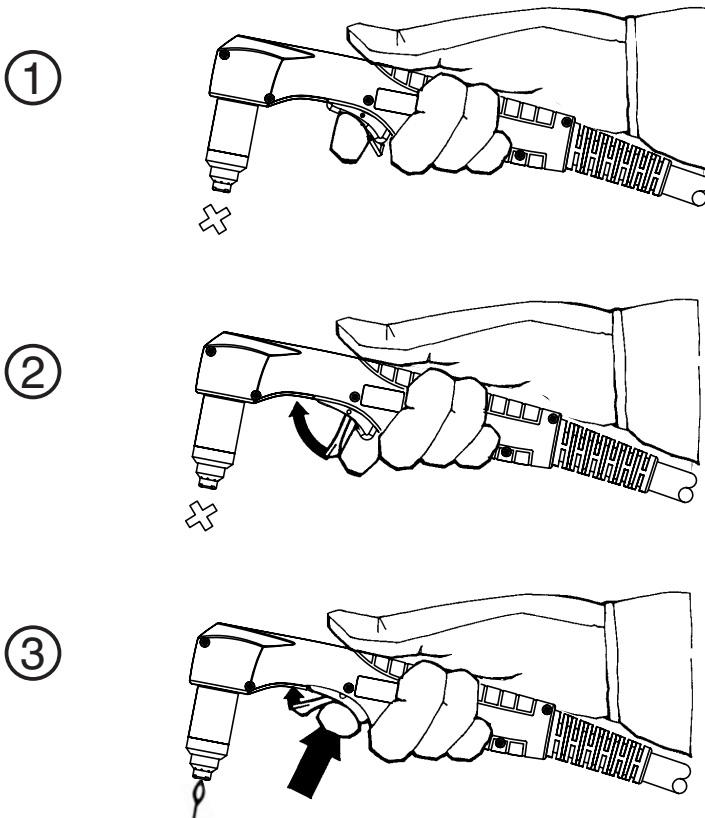



WARNING
SPARKS AND HOT METAL CAN INJURE EYES AND BURN SKIN

When firing the torch at an angle, sparks and hot metal will spray out from the nozzle. Point the torch away from yourself and others.

Attach the work clamp

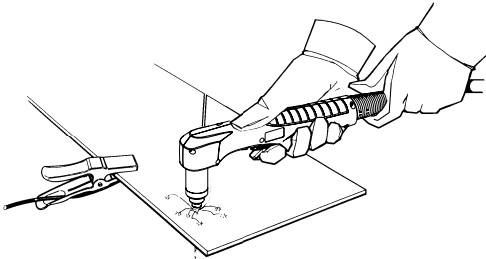

Attach the work clamp securely to the workpiece. Remove rust, paint or other coatings to ensure good electrical contact.

Attach the work clamp as close as possible to the area being cut, to reduce exposure to electromagnetic fields (EMF).

Do not attach the work clamp to the portion that will fall away.

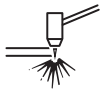

Starting a cut from the edge of the workpiece

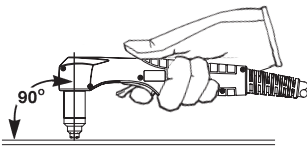

Hold the torch nozzle vertical at the edge of the workpiece.

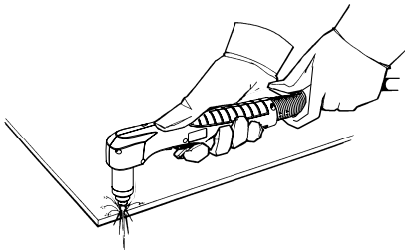

Start cutting from the edge of the workpiece.

Pause at the edge until the arc has completely cut through the workpiece.

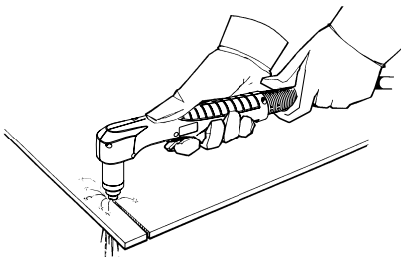

Then, proceed with the cut.

Hand torch cutting technique

Firing the torch unnecessarily reduces nozzle and electrode life.



When cutting, make sure that sparks are exiting from the bottom of the workpiece.

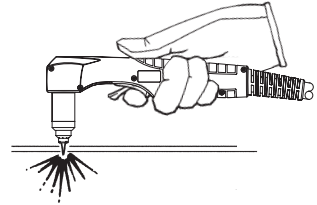

If sparks are spraying up from the workpiece, you are moving the torch too fast, or without sufficient power.

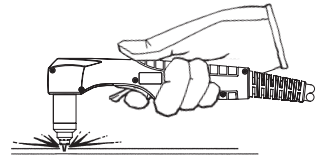

Position the torch nozzle at a vertical position and watch the arc as it cuts along the line.

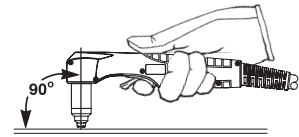

Unshielded consumables. Maintain an approximate 1/8 inch (3 mm) torch-to-work distance.

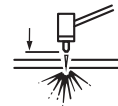

Shielded consumables. Do not push down on the torch when cutting. Lightly drag the torch across the workpiece to maintain a steady cut.

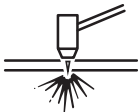

-
- Pulling the torch through the cut is easier than pushing it.
 - To cut thin material, reduce the amps until you get the best quality cut.
 - For straight-line cuts, use a straight edge as a guide. To cut circles, use a template or a Hypertherm circle cut guide, part number 027668.

Piercing

		<p style="text-align: center;">WARNING SPARKS AND HOT METAL CAN INJURE EYES AND BURN SKIN</p>
<p style="text-align: center;">When firing the torch at an angle, sparks and hot metal will spray out from the nozzle. Point the torch away from yourself and others.</p>		

Hold the torch so that the nozzle is within 1/8 inch (3 mm) from the workpiece before firing the torch.

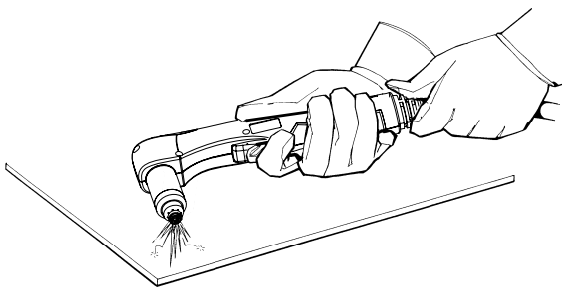

Fire the torch at an angle to the workpiece, then slowly rotate it to an upright position.

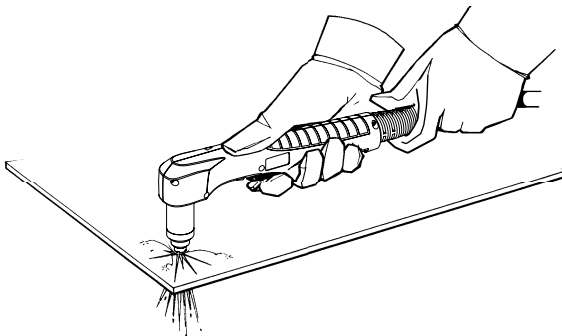

When sparks are exiting from the bottom of the workpiece, the arc has pierced through the material.

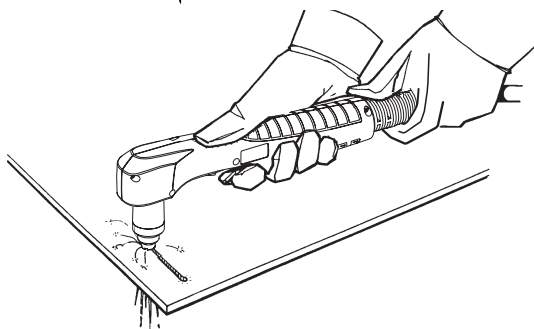

When the pierce is complete, proceed with the cut.

Gouging



		<p>WARNING SPARKS AND HOT METAL CAN INJURE EYES AND BURN SKIN</p>
<p>When firing the torch at an angle, sparks and hot metal will spray out from the nozzle. Point the torch away from yourself and others.</p>		

Hold the torch so that the nozzle is within 1/16 inch (1.5 mm) from the workpiece before firing the torch.

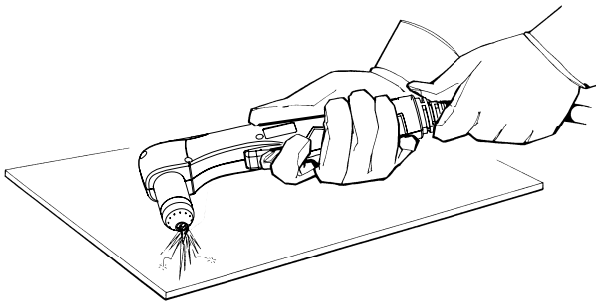

Hold the torch at a 45 degree angle to the work piece. Pull the trigger to obtain a pilot arc. Transfer the arc to the work piece.

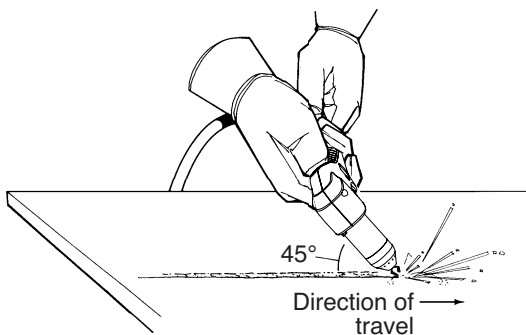

Maintain a 45° angle, approximately, from the workpiece.

Feed into the gouge.

NOTE: A heat shield is available for added hand and torch protection, part number 220049.

Cut charts

80 amp mechanized shielded consumables

- Torch-to-work distance for the following cut chart is 1/16 inch (1.5 mm) for all cuts.

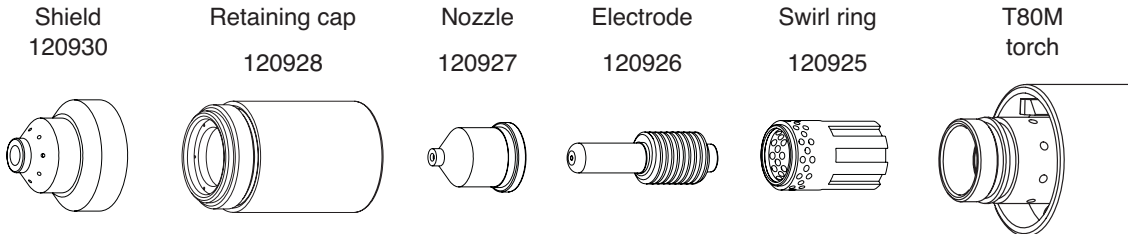

Mild steel

Arc current	Arc voltage	Pierce delay	Material thickness		Maximum travel speeds		Optimum travel speeds	
			Inches	mm	ipm	mm/min	ipm	mm/min
80	132	0.25	3/16"	4.8	216	5486	140	3556
	134	0.50	1/4"	6.4	161	4089	105	2667
	137		3/8"	9.5	94	2388	61	1549
	140		1/2"	12.7	60	1524	39	991
	145	1.00	5/8"	15.9	40	1016	26	660
	148	N/A	3/4"	19.0	31	787	20	508
	150		7/8"	22.2	23	584	15	381
	156		1"	25.4	16	406	10	254

Stainless steel

Arc current	Arc voltage	Pierce delay	Material thickness		Maximum travel speeds		Optimum travel speeds	
			inches	mm	ipm	mm/min	ipm	mm/min
80	134	0.25	3/16"	4.8	216	5486	140	3556
	136	0.50	1/4"	6.4	158	4013	103	2616
	139	0.75	3/8"	9.5	83	2108	54	1372
	142		1/2"	12.7	50	1270	33	838
	145	NA	5/8"	15.9	34	864	22	559
	150		3/4"	19.0	24	610	16	406
	153		1"	25.4	14	356	9	229

Aluminum

Arc current	Arc voltage	Pierce delay	Material thickness		Maximum travel speeds		Optimum travel speeds	
			inches	mm	ipm	mm/min	ipm	mm/min
80	134	0.25	1/8"	3.2	454	11532	295	7493
	139		1/4"	6.4	176	4470	114	2896
	143	0.75	3/8"	9.5	121	3073	60	1524
	146		1/2"	12.7	75	1905	37	940
	154	NA	3/4"	19.0	37	940	19	483

Maximum travel speeds are the fastest travel speeds possible to cut the material without regard to cut quality. Optimum travel speeds provide the best cut angle, least dross and best cut surface finish. **Remember that cut charts are intended to provide a good starting point for each different cut assignment.** Every cutting system requires "fine tuning" for each cutting application in order to obtain the desired cut quality.

OPERATION

60 amp mechanized shielded consumables

- Torch-to-work distance for the following cut chart is 1/16 inch (1.5 mm) for all cuts.

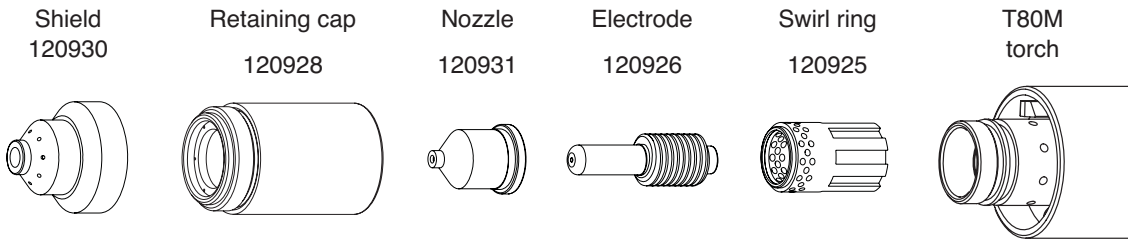

Mild steel

Arc current	Arc voltage	Pierce delay	Material thickness		Maximum travel speeds		Optimum travel speeds	
			inches	mm	ipm	mm/min	ipm	mm/min
60	134	0	16 ga	1.5	627	15926	502	12751
	134		10 ga	3.4	264	6706	211	5359
	138	0.25	1/4	6.4	132	3353	86	2184
	141	0.75	3/8	9.5	63	1600	41	1041
	141	1.50	1/2	12.7	42	1067	27	686
	147	NA	5/8	15.9	31	787	20	508
	153		3/4	19.0	22	559	14	356

Stainless steel

Arc current	Arc voltage	Pierce delay	Material thickness		Maximum travel speeds		Optimum travel speeds	
			inches	mm	ipm	mm/min	ipm	mm/min
60	134	0	16 ga	1.5	625	15875	406	10312
	136	0.25	10 ga	3.4	244	6198	159	4039
	139	0.50	1/4	6.4	110	2794	72	1829
	145	0.75	3/8	9.5	53	1346	34	864
	146	2.00	1/2	12.7	35	889	23	584
	149	NA	5/8	15.9	26	660	17	432
	154		3/4	19.0	18	457	12	305

Aluminum

Arc current	Arc voltage	Pierce delay	Material thickness		Maximum travel speeds		Optimum travel speeds	
			inches	mm	ipm	mm/min	ipm	mm/min
60	135	0	1/16	1.6	666	16916	433	10998
	138	0.25	1/8	3.2	400	10160	260	6604
	141		1/4	6.4	145	3683	94	2388
	146	0.75	3/8	9.5	74	1880	48	1219
	149	1.50	1/2	12.7	51	1295	30	762
	153	NA	5/8	15.9	33	838	21	533

Maximum travel speeds are the fastest travel speeds possible to cut the material without regard to cut quality. Optimum travel speeds provide the best cut angle, least dross and best cut surface finish. **Remember that cut charts are intended to provide a good starting point for each different cut assignment.** Every cutting system requires “fine tuning” for each cutting application to obtain the desired cut quality.

40 amp mechanized shielded consumables

- Torch-to-work distance for the following cut chart is 1/16 inch (1.5 mm) for all cuts.

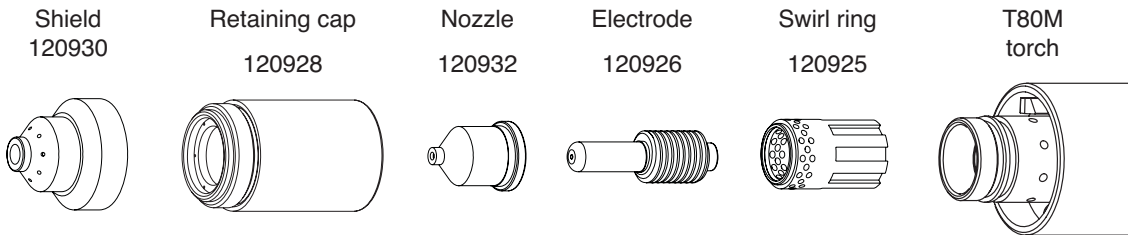

Mild steel

Arc current	Arc voltage	Pierce delay	Material thickness		Maximum travel speeds		Optimum travel speeds	
			inches	mm	ipm	mm/min	ipm	mm/min
25	147	0	26 ga	0.5	638	16205	415	10541
	148		22 ga	0.8	500	12700	325	8255
	149		18 ga	1.3	312	7925	203	5156
	152		16 ga	1.5	176	4470	114	2896
40	144	0.25	14 ga	1.9	640	16256	221	5613
	146	0.50	10 ga	3.4	151	3835	98	2489
	147	0.75	3/16	4.7	97	2464	63	1600
	149	1.00	1/4	6.4	74	1880	48	1219

Stainless steel

Arc current	Arc voltage	Pierce delay	Material thickness		Maximum travel speeds		Optimum travel speeds	
			inches	mm	ipm	mm/min	ipm	mm/min
25	139	0	26 ga	0.5	631	16027	410	10414
	139		22 ga	0.8	496	12598	322	8179
40	142	0.25	18 ga	1.3	592	15037	335	8509
	144		16 ga	1.5	374	9500	243	6172
	144	0.50	14 ga	1.9	221	5613	144	3658
	147		10 ga	3.4	107	2718	70	1778
	149	0.75	3/16	4.7	67	1702	44	1118
	149	1.00	1/4	6.4	47	1194	31	787

Aluminum

Arc current	Arc voltage	Pierce delay	Material thickness		Maximum travel speeds		Optimum travel speeds	
			inches	mm	ipm	mm/min	ipm	mm/min
25	150	0	1/32	0.8	610	15494	397	10084
	152		1/16	1.5	268	6807	174	4420
40	146	0.25	3/32	2.4	293	7442	190	4826
	149	0.50	1/8	3.2	204	5182	133	3378
	151	1.00	1/4	6.4	76	1930	49	1245

Maximum travel speeds are the fastest travel speeds possible to cut the material without regard to cut quality.

Optimum travel speeds provide the best cut angle, least dross and best cut surface finish. **Remember that cut charts are intended to provide a good starting point for each different cut assignment.** Every cutting system requires "fine tuning" for each cutting application in order to obtain the desired cut quality.

OPERATION

FineCut consumables

• Torch-to-work distance for the following cut chart is 0.08 inches (2.032 mm) for mild steel and 0.010 inches (0.254 mm) for stainless steel.

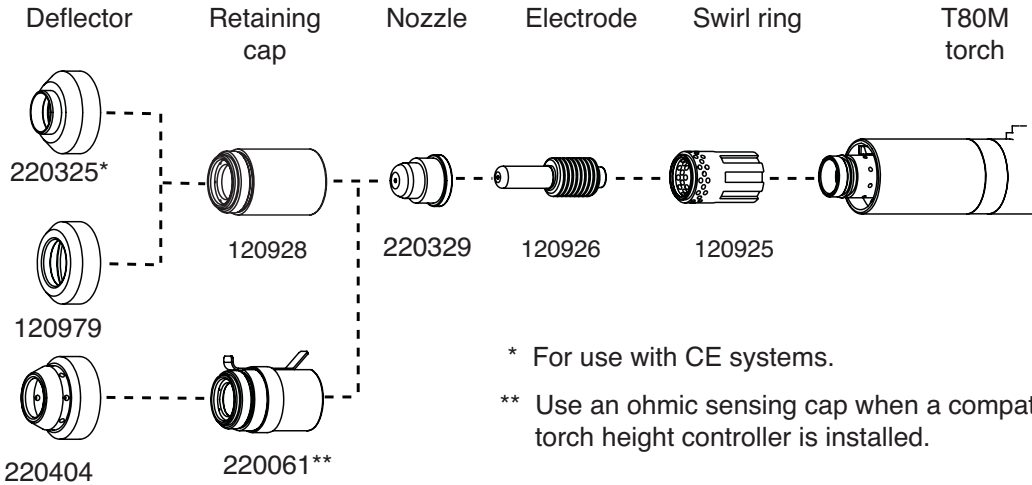

Mild steel

Arc current	Arc voltage	Material thickness		Approximate travel speeds	
		inches	mm	ipm	mm/min
50	76	10 ga	3.4	90	2286
40	83	10 ga	3.4	50	1270
45	77	12 ga	2.7	120	3048
40	81	12 ga	2.7	70	1778
	79	14 ga	1.9	135	3810
	79	16 ga	1.5	150	3810
	79	18 ga	1.2	150	2540
	78	20 ga	0.9	120	2540
30	80	24 ga	0.6	150	3174

Stainless steel

Arc current	Arc voltage	Material thickness		Approximate travel speeds	
		inches	mm	ipm	mm/min
50	63	10 ga	3.4	80	1905
40	73	10 ga	3.4	60	1524
45	63	12 ga	2.7	100	3174
40	72	12 ga	2.7	80	1905
	65	14 ga	1.9	150	3810
	64	16 ga	1.5	150	3810
	64	18 ga	1.2	150	3810
	65	20 ga	0.9	150	3810
30	66	24 ga	0.6	150	3810

40 amp mechanized unshielded consumables

- Torch-to-work distance for the following cut chart is 1/16 inch (1.5 mm) for all cuts.

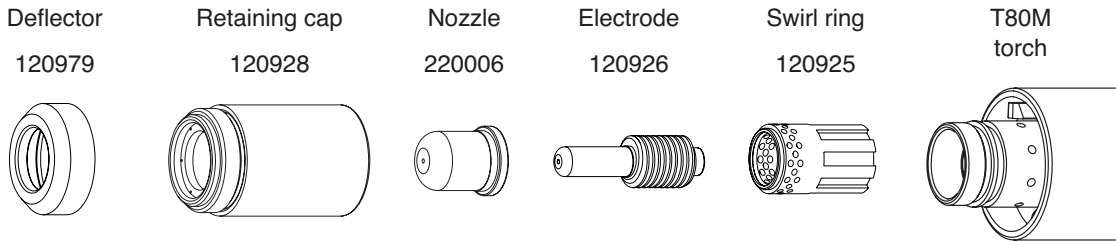

Mild steel

Arc current	Arc voltage	Pierce delay	Material thickness		Maximum travel speeds		Optimum travel speeds	
			inches	mm	ipm	mm/min	ipm	mm/min
25	125	0	26 ga	0.5	550	13970	353	8966
	128		22 ga	0.8	484	12294	315	8001
	130		18 ga	1.3	238	6045	155	3937
	131		16 ga	1.5	167	4242	109	2769
40	129	0.25	14 ga	1.9	326	8280	212	5385

Stainless steel

Arc current	Arc voltage	Pierce delay	Material thickness		Maximum travel speeds		Optimum travel speeds	
			inches	mm	ipm	mm/min	ipm	mm/min
25	127	0	26 ga	0.5	561	14249	365	9271
	127		22 ga	0.8	453	11506	295	7493
	123		18 ga	1.3	500	12700	325	8255
	127		16 ga	1.5	367	9322	239	6071
40	128	0.25	14 ga	1.9	220	5588	143	3632

Aluminum

Arc current	Arc voltage	Pierce delay	Material thickness		Maximum travel speeds		Optimum travel speeds	
			inches	mm	ipm	mm/min	ipm	mm/min
25	125	0	1/32	0.8	564	14326	366	9296
	127		1/16	1.5	236	5994	153	3886
40	127	0.25	3/32	2.4	261	6629	170	4318

Maximum travel speeds are the fastest travel speeds possible to cut the material without regard to cut quality. Optimum travel speeds provide the best cut angle, least dross and best cut surface finish. **Remember that cut charts are intended to provide a good starting point for each different cut assignment.** Every cutting system requires "fine tuning" for each cutting application in order to obtain the desired cut quality.

Section 5

MAINTENANCE AND PARTS



In this section:

Routine maintenance	5-2
Inspect the consumables.....	5-3
Controls and indicators.....	5-4
Indicator LEDs	5-4
Basic troubleshooting	5-5
System circuit diagram	5-8
Technical questions	5-9
Parts	5-9
Torch parts	5-9
Power supply parts	5-10
Accessories	5-10

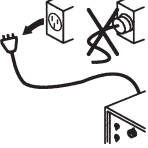

Routine maintenance

		WARNING ELECTRIC SHOCK CAN KILL
-----------------------------------------------------------------------------------	-----------------------------------------------------------------------------------	--------------------------------------------------

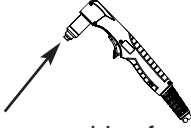
	<p>Disconnect electrical power before performing any maintenance. All work requiring removal of the power supply cover must be performed by a qualified technician.</p>
-----------------------------------------------------------------------------------	--------------------------------------------------------------------------------------------------------------------------------------------------------------------------------------------

 Each Use	 Check gas pressure.	 Check consumables for wear and proper installation.
------------------------------------------------------------------------------------------------------	----------------------------------------------------------------------------------------------------------	-------------------------------------------------------------------------------------------------------------------------------------------

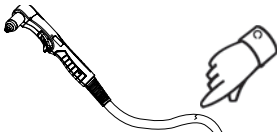
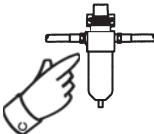

 Each Week		Check torch cap-on safety switch: observe that red fault LED and yellow torch cap LED illuminate when cap is loosened.
-------------------------------------------------------------------------------------------------------	-----------------------------------------------------------------------------------	------------------------------------------------------------------------------------------------------------------------

 3 Months	 Replace damaged labels.	 Check trigger for damage. Check torch body for cracks or exposed wires.
-------------------------------------------------------------------------------------------------------	---------------------------------------------------------------------------------------------------------------	---------------------------------------------------------------------------------------------------------------------------------------------------------------

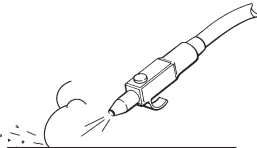
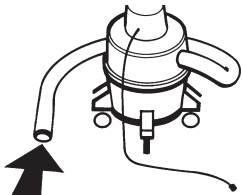
 Replace damaged power cord or plug.	 Replace damaged torch lead.	 Check pressure hose, filter element, and connections for leaks.
----------------------------------------------------------------------------------------------------------------------------	--------------------------------------------------------------------------------------------------------------------	---------------------------------------------------------------------------------------------------------------------------------------------------------

 6 Months		 Clean the inside of the power supply with air pressure or vacuum.
--------------------------------------------------------------------------------------------------------	-------------------------------------------------------------------------------------	----------------------------------------------------------------------------------------------------------------------------------------------------------

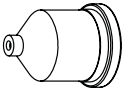
Inspect the consumables

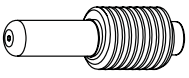
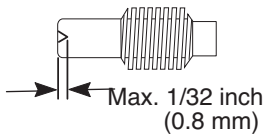
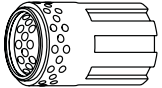
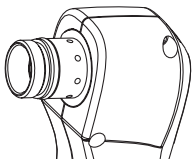
<i>Part</i>	<i>Check for</i>	<i>Action</i>
 <p>Nozzle Center hole</p>	<p>Roundness of through hole</p>  <p>Good Worn</p>	<p>Replace</p>
 <p>Electrode Center surface</p>	 <p>Maximum pit depth 1/32 inch (0.8 mm)</p>	<p>Replace</p>
 <p>Swirl ring External surfaces Central bore (I.D.) Gas holes</p>	<p>Damage or debris</p> <p>Does electrode slide easily?</p> <p>Blocked holes</p>	<p>Replace</p> <p>Replace</p> <p>Replace</p>
 <p>Torch o-ring External surfaces</p>	<p>Damage or wear</p> <p>Dry surface</p>	<p>Replace</p> <p>Apply a thin film of Hypertherm grease (part number 027055).</p>

Controls and indicators

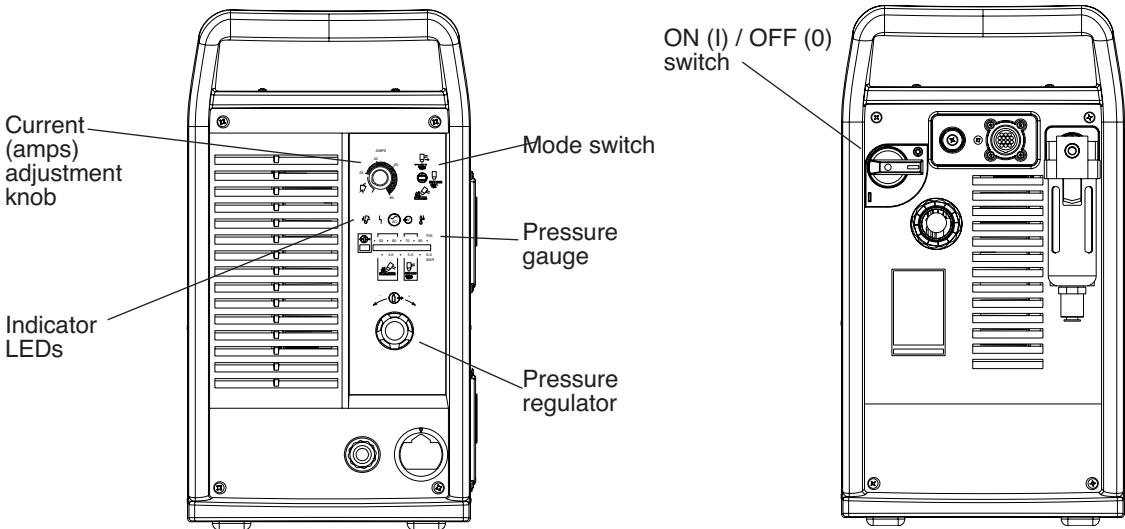

Indicator LEDs



Green power ON LED

When illuminated, indicates that power is applied to system and power switch is ON (I).



Gas pressure LED

Yellow: When flashing, indicates that the gas pressure is below 60 psig (4.1 bar) for cutting, or 40 psig (2.8 bar) for gouging.
Green: When illuminated, indicates that there is acceptable gas pressure for torch operation.



Yellow torch cap LED

When illuminated, indicates that the retaining cap is loose or not installed.

Note: The condition must be corrected and power turned OFF and then ON again to clear the LED.



Yellow temperature LED

When illuminated, indicates that the power supply temperature has exceeded its operating limit.



Red fault LED

When illuminated, indicates that a fault condition exists, which prevents system operation.



Yellow low line voltage LED

When illuminated, indicates that line voltage is below 170 VAC or above 680 VAC. On CE units. It can also indicate a missing phase.

Basic troubleshooting

Problem

Cause / Solution

1. The ON/OFF power switch is set to ON (I), and the power ON (green) LED is not illuminated.



Note: The fan turns on and off automatically. The fan may not be in operation even though the power is ON (I).

2. The power ON (green) and gas pressure (yellow) LEDs are flashing and the fault (red) LED is illuminated.



3. The power ON, low line voltage (yellow), and fault (red) LEDs are illuminated.



4. The power ON (green), temperature (yellow) and fault (red) LEDs are illuminated.



- 1.1 **The power cord is not plugged into the power receptacle.**
Plug the power cord into the receptacle.
- 1.2 **The disconnect power switch is not set to ON or there is no power available to the disconnect power switch box.**
Turn on the power at the main power panel or at the disconnect power switch box.

- 2.1 **The gas supply is turned OFF or not connected to the power supply.**
Check that the gas is turned on and is connected to the power supply.
- 2.2 **The incoming gas pressure is too low.**
Set incoming gas pressure to 90-120 psig (6.2-8.3 bar). Check that there are no leaks in the gas supply line.
- 2.3 **Output gas pressure is set too low for selected mode.**
Adjust gas pressure. See Section 4 for pressure settings.

- 3.1 **Line voltage is too low, too high, or a phase (CE system only) is missing.**
Have a qualified technician check the incoming power.

- 4.1 **One of the internal thermostat switches has opened due to overheating or extremely low temperature.**
Leave the power supply on to allow the fan to cool the power supply (overheating). Move the power supply to a warm location (extreme cold).

Basic troubleshooting (continued)

Problem	Cause / Solution
5. The power ON (green), torch cap (yellow) and fault (red) LEDs are illuminated.	<p>5.1 Retaining cap is loose or removed from the torch. Turn off power supply and tighten or install torch consumables. See Section 4, <i>Install the torch consumables</i>.</p> <p>If the torch consumables become loose or were removed while the power supply is on, turn off the power supply, correct the problem and then turn on the power supply to clear this fault.</p>
	
6. The arc does not transfer to the workpiece.	<p>6.1 The work clamp is not connected to the workpiece, or the work clamp is broken. Connect or repair the work clamp.</p> <p>6.2 The work clamp is not making good metal-to-metal contact. Clean the area where the clamp contacts the workpiece.</p> <p>6.3 The torch is too far away from the workpiece. Move the torch head closer to the workpiece and start the torch again. See Section 4, <i>Hand torch operation</i>.</p>
7. The arc blows out, but re-ignites when the torch switch is pressed again.	<p>7.1 The consumable parts are worn or damaged. Inspect and change the consumables, as necessary. See <i>Inspect the consumables</i>, in this section and Section 4, <i>Hand torch operation</i>.</p> <p>7.2 The gas pressure is incorrect. Adjust the operating gas pressure. See Section 4, <i>Adjust gas pressure and current setting</i>. Check that the gas pressure to the power supply is not less than 90 psig (6.1 bar) at a flow of 6.7 scfm (189 l/m).</p> <p>7.3 The gas filter element outside the power supply is contaminated. Replace filter element.</p>

Basic troubleshooting (continued)

Problem	Cause / Solution
8. The arc sputters and hisses.	<p>8.1 <i>The gas filter element outside the power supply is contaminated.</i> Replace filter element.</p> <p>8.2 <i>There is water in the air line.</i> Clean air filter or add additional air filtration to power supply. See Section 3, <i>Additional gas filtration.</i></p> <p>8.3 <i>Worn or incorrectly installed consumables.</i> Inspect consumables. Replace if necessary.</p>
9. Cut quality is not good.	<p>9.1 <i>Consumables are worn or the torch is being used incorrectly.</i> See <i>Inspect the consumables</i>, in this section. See Section 4, <i>Hand torch operation.</i></p>
10. The power ON (green) and fault (red) LEDs are flashing.	<p>10.1 <i>Self diagnostic failure.</i> System needs repair.</p>
11. The power ON (green) and fault (red) LEDs are illuminated after power is turned on.	<p>11.1 <i>Start signal ON when system power is initiated.</i> Turn the power OFF and then ON again.</p>
12. The power ON (green) and fault (red) LEDs are illuminated for 10 seconds after trigger switch is activated.	<p>12.1 <i>Consumables stuck or jammed.</i> Turn power OFF and check the consumables.</p>

System circuit diagram

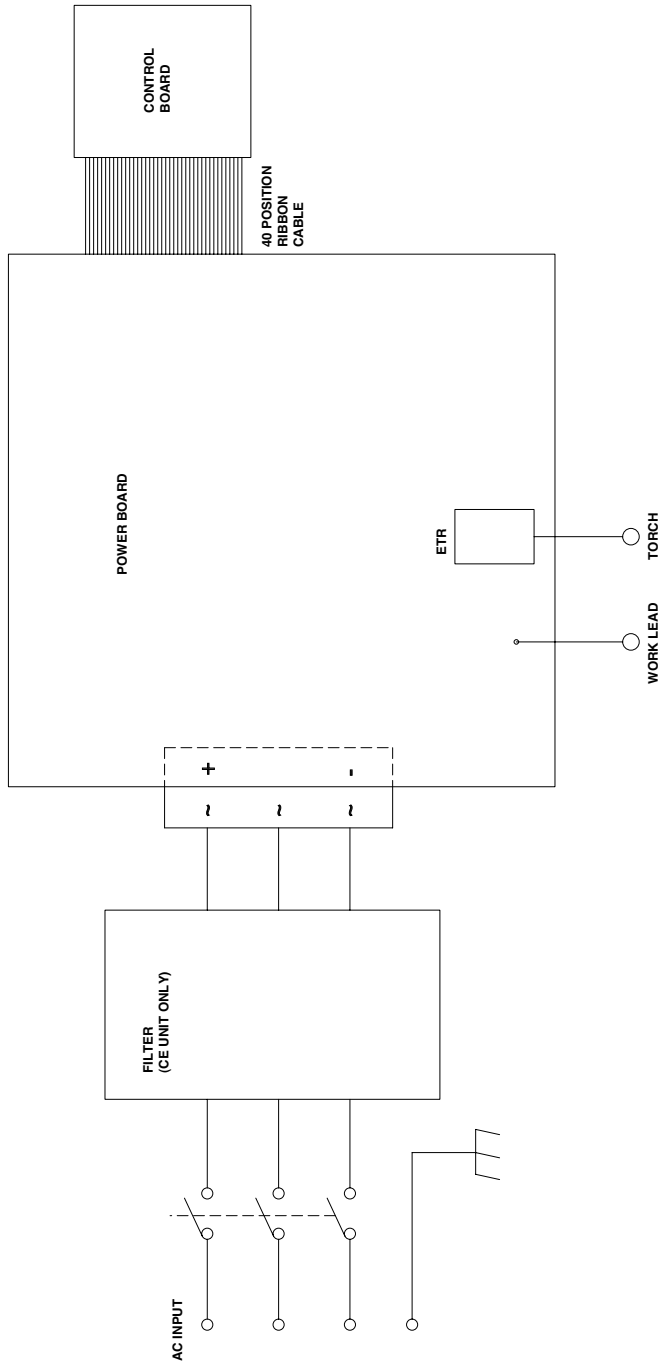

Technical questions

If you are unable to fix the problem by following this basic troubleshooting guide or if you need further assistance:

1. Call your Hypertherm distributor or authorized Hypertherm repair facility.
2. Call the nearest Hypertherm Technical Service team listed in the front of this manual.

Parts

Torch parts

See Section 4, *T80 consumable configurations* and *T80M consumable configurations*, for part numbers and illustrations of the consumables.

087001	T80 hand torch assembly, 25 ft (7.6 m) lead
087002	T80 hand torch assembly, 50 ft (15.2 m) lead
087047	T80 hand torch assembly, 75 ft (22.5 m) lead
087003	T80M machine torch assembly, 15 ft (4.6 m) lead
087004	T80M machine torch assembly, 25 ft (7.6 m) lead
087005	T80M machine torch assembly, 35 ft (10.7 m) lead
087006	T80M machine torch assembly, 50 ft (15.2 m) lead
087048	T80M machine torch assembly, 75 ft (22.5 m) lead
027055	Silicon lubricant, 1/4 Oz. Tube
015337	NIP: 1/4 NPT Qdisc STL (Non-CE)
015145	Adapter: 1/4 NPT x G1/4 BSPP RH BRS (CE)
058519	Torch o-ring
128644	T80 hand torch handle replacement kit (5 screws included)
075586	T80 hand torch handle screw (5 required)

Power supply parts

128620	Cover assembly, non-CE (12 screws included)
128621	Cover assembly, CE (12 screws included)
075533	Cover screws (individual cover screw)
128627	Filter bowl with fittings
129654	ETR door assembly
128387	Consumables box
123106	Work clamp with cable and strain relief
128666	Kit: Powermax1000/1250 power cord, standard
128667	Kit: Powermax1250 power cord, CE
128631	Kit: Powermax1250 labels
128632	Kit: Powermax1250 labels, CE
128672	ON/OFF switch

Accessories

128646	Wheel kit
128647 011092	Optional air filtration kit Replacement filter for optional air filtration kit
011093	Replacement filter element for filter kit
027668	Circle cutting guide — deluxe
127102	Circle cutting guide — basic
027684	Replacement bushing for circle cutting guide assembly
128145	50 ft (15 m) work cable with clamp
023206	CNC machine interface cable with voltage divider
128658	Hand torch heat shield, gouging
128650	On/off pendant for machine torch, 25 ft (7.5 m)
128651	On/off pendant for machine torch, 50 ft (15 m)
128652	On/off pendant for machine torch, 75 ft (22.5 m)
128711	Strain relief inserts, standard cord
024548	Leather torch lead sheathing
128888	FineCut kit: Powermax1000/1250/1650
128889	FineCut kit: Powermax1000/1250/1650, CE