

CE



CHRISTIE
TOTAL TORQUE SOLUTIONS

DIGITAL BATTERY TORQUE WRENCH (BC-RAD SELECT)

USER GUIDE



W.CHRISTIE (INDUSTRIAL) LTD
CHRISTIE HOUSE, MEADOWBANK ROAD, ROTHERHAM, SOUTH YORKSHIRE, S61 2NF, UK
T: +44(0)1709 550088 F: +44(0)1709 550030 E: INFO:WCHRISTIE.COM W: WWW.WCHRISTIE.COM

CONTENTS

<u>Page</u>	<u>Description</u>
-	Issue Introduction
1	Important Safety Notice BC-RAD Select System Safety
2	BC-RAD Select Li-Ion Battery Pack Safety
3-4	1.0 – General Information
3	1.1 – System Components
3-4	1.2 – Specifications
4-7	2.0 – Tool System
5	2.1 – Tool Handle
5	2.2 – LED Display Interface
6	2.3 – BC-RAD Select Li-Ion Battery Pack
7	2.4 – BC-RAD Select Battery Charger
8-9	3.0 – LED Display Operation
8	3.1 – Torque Select Mode
9	3.2 – Lock Mode
9	4.0 – Calibration
10-13	5.0 – General Operating Instructions
10	5.1 – Reaction Arm
13	5.2 – Torque Operation
13	6.0 – Troubleshooting
14	E.C. Declaration of Conformity
--	Calibration Certificate
15	7.0 – Contact Us

ISSUE

Description	Issue	Date	Initials
First Issue	1	Nov 2015	RA

INTRODUCTION

The BC-RAD Select Battery Torque Wrench is a handheld, battery driven reversible non-impacting torque delivery power tool intended to tighten and un-tighten nuts, bolts and threaded fasteners.

The BC-RAD Select Electrical torque wrench must always be used with the following:-

- Battery Pack Supplied
- Impact Quality Sockets
- Ring and pin fastener system (or similar)
- Reaction Arm
- 240V or 110V electrical battery charger (dependant on model purchased)

If the intended use is other than for nuts, bolts and threaded fasteners contact W. Christie (Industrial) LTD for guidance.

It is the responsibility of the user to consider associated site risks before introducing the equipment into the work-place.

IMPORTANT SAFETY NOTICE

READ ALL SAFETY WARNINGS AND ALL INSTRUCTIONS. FAILURE TO FOLLOW THE WARNINGS AND INSTRUCTIONS MAY RESULT IN ELECTRIC SHOCK, FIRE, AND/OR SERIOUS INJURY.

BC-RAD SELECT TOOLS ARE SAFE AND RELIABLE. NOT FOLLOWING PRECAUTIONS AND INSTRUCTIONS OUTLINED HERE CAN RESULT IN DAMAGE TO THE TOOL, AND INJURY TO THE OPERATOR AND FELLOW WORKERS.

W. CHRISTIE (INDUSTRIAL) LTD IS NOT RESPONSIBLE FOR ANY SUCH INJURY.

BC-RAD SELECT SYSTEM SAFETY

The intended use of the BC-RAD Select Tool System is for commercial and industrial bolting applications.

Do not operate the BC-RAD Select Tool System before reading and understanding this user manual and noting the Safety Notices displayed on the BC-RAD Select Tool System and throughout this manual.

Only qualified personnel with training in the safe operation of torque tooling and the BC-RAD Select Tool System should attempt the installation, operation and diagnosis of the BC-RAD Select Tool System.

The BC-RAD Select Tool System is connected to high voltage power and consists of external rotating parts. Improper training and use can cause serious or fatal injury.

Do not disassemble or attempt to repair the BC-RAD Select Tool System; doing so will void warranty. If breakdown, malfunction or damage occurs and the BC-RAD Select Tool System fails to operate correctly, contact W. Christie (Industrial) LTD Technical Support (refer to Section 7.0 – Contact Us).

The BC-RAD Select Tool System should only be used if environmental storage and operation specifications have been met. Refer to Section 1.2.3 – Environmental Specifications.

Do not operate the BC-RAD Select Tool System in explosive atmospheres, including, but not limited to, the presence of flammable liquids, gases or dust. The BC-RAD Select Tool System creates sparks which could ignite these substances.

Do not expose the BC-RAD Select Tool System to wet conditions. Water in the BC-RAD Select Tool System will cause damage to the tool and increase the risk of electric shock.

After long durations of use, the BC-RAD Select Tool System will become hot. It is recommended to use the tool in short intervals and allow for cooling between uses to prevent injury to the operator or damage to the BC-RAD Select Tool System.

While operating the BC-RAD Select Tool System, always wear safety goggles and keep all body parts clear of moving parts and the reaction arm contact point.

Never exceed the Maximum Torque of the BC-RAD Select Tool System. Failure to comply will result in void warranty.

The BC-RAD Select Tool System has been calibrated by a qualified Calibration Technician; calibration must be done by a qualified Calibration Technician. Improper calibration can cause damage to the tool and joint.

BC-RAD SELECT LI-ION BATTERY PACK SAFETY

Only use the BC-RAD Select Li-Ion Battery Pack with the B-RAD Select Tool System. The use of other batteries with the BC-RAD Select Tool System will cause damage to the tool.

The BC-RAD Select Li-Ion Battery Pack should only be charged on the BC-RAD Select Battery Charger. If an incompatible charger is used, damage to the BC-RAD Select Battery will occur.

Keep the BC-RAD Select Li-Ion Battery Pack away from any metal objects. If the battery terminals are connected by a metal object, the battery will short and will cause damage to the battery and injury to the operator.

Do not expose the BC-RAD Select Li-Ion Battery Pack to wet conditions. This will cause damage to the BC-RAD Select Battery and increase the risk of electric shock.

Do not use faulty or deformed BC-RAD Select Batteries. Do not attempt to open the BC-RAD Select Battery. Do not short circuit the BC-RAD Select Battery. Failure to comply will cause damage to the BC-RAD Select Battery and injury to the operator.

If liquid is ejected from the BC-RAD Select Battery, avoid contact. If contact with skin occurs, immediately flush with water. If contact with eyes occurs, immediately flush with water and seek medical aid. Liquid from the BC-RAD Select Battery may cause irritation and/or burns.

BC-RAD Select Li-Ion Battery Packs cannot be disposed of with regular waste. Return BC-RAD Select Batteries to W. Christie (Industrial) LTD.

Ensure battery is changed when the charge level reaches 2 bars. Using the tool at 2 or less bars of battery power will affect calibration figures

1.0 – GENERAL INFORMATION

1.1 – System Components

The BC-RAD Select Tool System is supplied with the following parts:

- BC-RAD Select Tool (Figure 1.1-1)
- Two BC-RAD Select Li-Ion Battery Packs (Figure 1.1-2)
- BC-RAD Select Battery Charger (Figure 1.1-3)
- Standard Reaction Arm and Snap Ring (Figure 1.1-4)
- Calibration Certificate
- User Manual



Figure 1.1-1: BC-RAD Select



Figure 1.1-2: BC-RAD Select Li-Ion Battery Pack



Figure 1.1-3: BC-RAD Select Battery Charger



Figure 1.1-4: Standard Reaction Arm

1.2 - Specifications

1.2.1 – Torque Ranges

The following table outlines the torque ranges, in Newton-Meters, of each BC-RAD Select Tool System:

Model	Weight (Kg)	Max Speed (RPM)		Torque Range (Nm)		Square Drive
		Single	Auto 2	Minimum	Maximum	
BC-RAD 3X Select	3.8	40	N/A	70	275	3/4"
BC-RAD 7X Select	3.4	13	N/A	175	700	3/4"
BC-RAD 7XA Select	4.2	N/A	57.2	200	700	3/4"
BC-RAD 14X Select	3.7	5.8	N/A	300	1400	3/4"
BC-RAD 14XA Select	4.5	N/A	19.9	300	1400	3/4"
BC-RAD 20X Select	4.0	3.8	N/A	400	2000	1"
BC-RAD 20XA Select	4.85	N/A	18	400	2000	1"
BC-RAD 40X Select	6.0	2	N/A	800	4000	1"
BC-RAD 40XA Select	7.3	N/A	13	800	4000	1"

1.2.2 – Battery Specifications

Ensure that all Battery Specifications are followed when utilising the BC-RAD Select Tool System.

Battery Output	
Voltage	18 VDC
Current	30 A
Charge Time	60 minutes
Charger Voltage	
Input	115 VAC
Output	12 – 18 VDC
Charger Output Current	2.5 A

Table 1.2.2: Battery Specifications

1.2.3 – Environmental Specifications

CAUTION Only operate the BC-RAD Select Tool System if the following environmental storage and operation specifications have been met.

Temperature Ranges	°C	°F
Operating Temperature	0 – 35	32 – 95
Charging Temperature	0 – 50	32 – 122
Storage Temperature	-25 – 70	-13 – 158
Humidity	10% to 90% non-condensing	
Shock	10G according to DIN IEC 68-2-6/29	
Vibration	1G, 10-150Hz according to DIN IEC 68-2-6/29	
Required Operating Conditions	- Non explosive atmosphere - Dry location	

Table 1.2.3: Environmental Specifications

1.2.4 – Cycle of Operation

A Cycle of Operation or a Tool Cycle as used in this manual is defined as:

- 5 seconds forward
- 10 seconds rest and switch to reverse mode
- 5 seconds reverse mode
- 20 seconds rest and switch to forward mode

Note: An actual Torque Cycle may vary from the general definition above.

2.0 – TOOL SYSTEM

The following sections give a visual and functional description of the Tool Handle, LED Display Interface, BC-RAD Select Li-Ion Battery Pack and BC-RAD Select Battery Charger.

2.1 Tool Handle

The BC-RAD Select (Figure 2.1-1) is activated with a Trigger Switch. The Forward/Reverse Switch controls the direction of rotation. Torque values and tool information are displayed on the 4-digit LED display. Two buttons are used to enter the desired torque setting. The BC-RAD Select Li-Ion Battery Pack is attached to the bottom of the Tool Handle.

1. Trigger Switch – tool activation.
2. Forward/Reverse Switch – controls direction of rotation.
3. LED Display and Up/Down Button Module.
4. BC-RAD Select Li-Ion Battery Pack – refer to Section 2.3 – BC-RAD Select Li-Ion Battery Pack.
5. Battery Release Button – refer to Section 2.3.1 – Insert/Remove the BC-RAD Select Li-Ion Battery Pack.

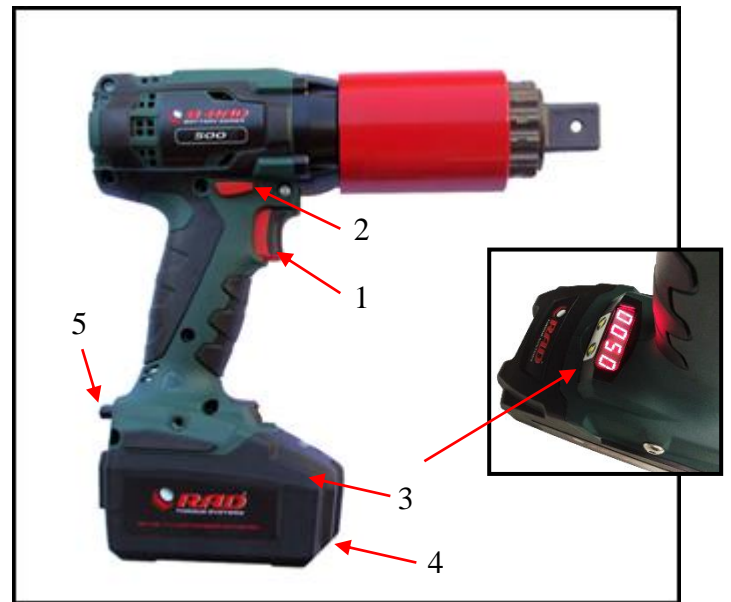

Figure 2.1-1: BC-RAD Select and LED Display

2.1.1 – Trigger Lock

The Trigger Lock is useful while transporting or storing the BC-RAD Select. The Trigger Lock disables the use of the On/Off Trigger, therefore disabling the tool. It is suggested that while the BC-RAD Select is not in use, the Trigger Lock should be enabled.

To enable the Trigger Lock:

- Slide the Forward/Reverse Switch to the Centre Position (neither fully to the right nor fully to the left).

Note: The On/Off Trigger cannot be depressed.

To disable the Trigger Lock:

- Slide the Forward/Reverse Switch to the Forward Position or the Reverse Position.

Note: The On/Off Trigger can be depressed.

2.2 – LED Display Interface

The LED Display and Up/Down Button Interface is the user control module for the BC-RAD Select Tool System (See Figure 2.2-1). The LED Display has 4 numeric digits, used to display torque values in Torque Select mode and the calibration menus in Calibration mode. The 2 Up/Down navigation buttons are used to increment and decrement numeric values, as well as enter and navigate the various menu systems in the module. The LED Display will light a small indicator LED near each button to confirm that a button is being pushed or held down.

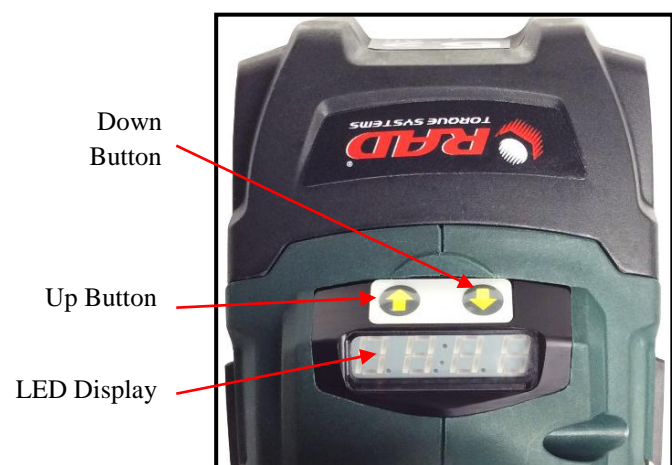

Figure 2.2-1: LED Display

2.3 – BC-RAD Select Li-Ion Battery Pack

CAUTION Only use the BC-RAD Select Li-Ion Battery Pack with the BC-RAD Select Tool System. Using third-party batteries may damage the BC-RAD Select Tool System.

CAUTION Keep the BC-RAD Select Li-Ion Battery Pack away from any metal objects. If the battery terminals are connected by a metal object, the battery will short and cause damage to the battery and injury to the operator.

The BC-RAD Select Li-Ion Battery Pack supplies power to the tool; for the BC-RAD Select to perform best, ensure the BC-RAD Select Battery is fully charged and in good condition before use. In optimal conditions, the BC-RAD Select Battery should be capable of approximately 100 Torque Cycles at 50% of the Maximum Torque on a joint with a hardness of approximately 10 degrees.

Note: The application torque, joint hardness, battery condition, age and operating temperature will affect the actual number of Torque Cycles per charge.

2.3.1 – Insert / Remove the BC-RAD Select Li-Ion Battery Pack

To insert the BC-RAD Select Battery:

1. Ensure the On/Off Trigger is in the Off Position (not depressed).
2. Align the BC-RAD Select Battery with the bottom of the Tool Handle.
3. Slide the BC-RAD Select Battery into place until it is fully seated.

Note: A click will confirm that the BC-RAD Select Battery is locked in place.

4. Check that the BC-RAD Select Battery is locked in place by trying to slide it out of place.

To remove the BC-RAD Select Battery:

1. Press and hold the Battery Release Button.
2. Slide the BC-RAD Select Battery away from the Tool Handle.

2.3.2 - Check BC-RAD Select Battery Charge

To check the BC-RAD Select Battery Charge:

1. Press the “Charge” button on the BC-RAD Select Battery (Figure 2.3.2-1).

Result: The Red or Green Bars will light up. If all the Bars are illuminated, the Battery is fully charged. If none of the Bars are illuminated, the BC-RAD Select Battery is completely discharged and needs charging (refer to Section 2.4.1 – Charging the BC-RAD Select Li-Ion Battery Pack).

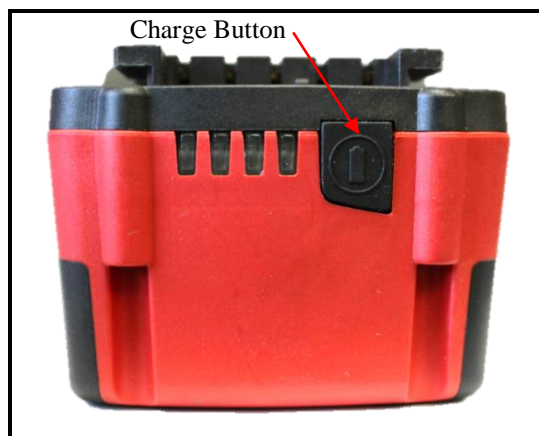

Figure 2.3.2-1: BC-RAD Select Li-Ion Battery Pack

2.4 BC-RAD Select Battery Charger

CAUTION The BC-RAD Select Li-Ion Battery Pack should only be charged on the BC-RAD Select Battery Charger. If an incompatible charger is used, damage to the BC-RAD Select Battery will occur.

The Charging Status Display (Figure 2.4-1) on the BC-RAD Select Battery Charger is used to notify the operator when the BC-RAD Select Battery is charging, when the charge is complete and if there is an error.

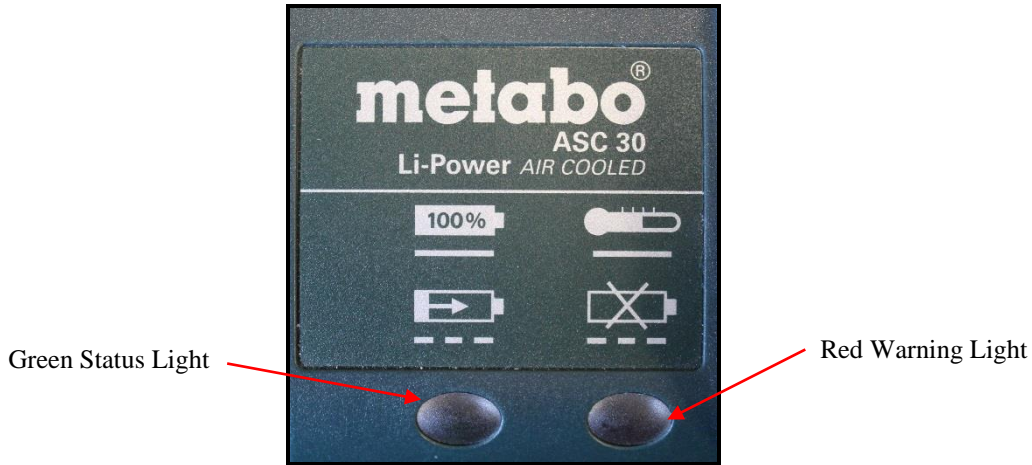

Figure 2.4-1: Charging Status Display

2.4.1 – Charging the BC-RAD Select Li-Ion Battery Pack

Note: The temperature range for charging is 0°C to 50°C (32°F to 122°F).

To charge the BC-RAD Select Battery:

1. Plug the BC-RAD Select Battery Charger into the wall outlet.

Result: The Red Warning Light will turn on for one second and then the Green Status Light will turn on for one second.

2. Align the BC-RAD Select Battery with the BC-RAD Select Battery Charger.
3. Slide the BC-RAD Select Battery into place.

Result: The Green Status Light will flash while the BC-RAD Select Battery is charging.

When the BC-RAD Select Battery has been fully charged, the Green Status Light will stop flashing and stay illuminated. Until the BC-RAD Select Battery is removed from the BC-RAD Select Charger, the Charger will switch to conservation mode which will maintain the battery charge at maximum capacity.

To remove the BC-RAD Select Battery:

1. Slide the BC-RAD Select Battery away from the BC-RAD Select Charger.
2. Check that the BC-RAD Select Battery is fully charged (refer to Section 2.3.2 – Check BC-RAD Select Battery Charge).

2.4.2 – Charging Errors

The Red Warning Light is on:

The BC-RAD Select Battery is not charging because its temperature is not within the required temperature range for charging. When the BC-RAD Select Battery's temperature moves within the required range for charging, the Red Warning Light will turn off and charging will commence.

The Red Warning Light is flashing:

The BC-RAD Select Battery may be placed incorrectly on the BC-RAD Select Battery Charger. Remove the BC-RAD Select Battery and replace it correctly on the BC-RAD Select Battery Charger. If the Red Warning Light continues to flash, the BC-RAD Select Battery is defective; remove the BC-RAD Select Battery immediately.

If these problems continue, contact W. Christie (Industrial) LTD. Technical Support (refer to Section 7.0 – Contact Us)

3.0 – LED DISPLAY OPERATION

CAUTION The LED Display and Button Module is susceptible to mechanical shock and any excessive force exerted on the module may result in damage.

CAUTION The LED Display can be damaged by moisture or water and high temperatures. Avoid such conditions and gently wipe clean or let dry before use.

The LED Display and Up/Down Button Module is used to enter torque values, select units of measurement, and calibrate the tool. This section describes the functions and use of each setting within the Interface.

3.1 – Torque Select Mode

CAUTION The tool must be calibrated before use. If the LED Display shows anything but the normal Torque Select screen, the Unit Select screen, or the Calibration Menus, contact W. Christie (Industrial) LTD. Technical Support (refer to Section 7.0 – Contact Us).

When the BC-RAD Select Li-Ion Battery is first attached to the BC-RAD Select handle, the LED Display Module will remain off until the Trigger Switch is depressed. The LED Display will start in Torque Select Mode when the Trigger Switch is depressed.

Note: If the tool has just been calibrated, the LED Display will show the tool's rated minimum torque.

Note: If the tool has not been calibrated, the LED Display will display the minimum of the Default gearbox, which is 250 lbf.ft.

When Nm (metric) units are used, the LED Display will light a small LED dot in the bottom left corner of the display (Refer to Section 3.1.2 – Unit Select Menu).

Important The BC-RAD Select Tool System must be calibrated before use. If at any time the Default gearbox range appears on the LED Display, contact W. Christie (Industrial) LTD. See Section 7.0 – Contact us for information.

3.1.1 – Setting Torque

To change the torque value displayed on the LED Display:

1. Press either the Up or the Down button to increment or decrement the number.
2. The torque value will increment/decrement in multiples of 10 units when a button is pressed briefly or repeatedly.
3. If the LED Display shows a torque value as a multiple of 100 (for example 400 lbf.ft), the Display will increment or decrement the number by 100 as long as a button is pushed and held down.
4. If the Display shows a torque value between multiples of 100 units (for example 430 lbf.ft), the Display will change by 10 units when a button is pressed and held down, until the number again reaches a multiple of 100.
5. The LED Display will automatically save the selected torque value after 5 seconds, enabling the user to remove and replace the battery without losing the selected torque value.

3.1.2 – Unit Select Menu

The display units can be changed at any time using the Unit Select menu.

To enter the menu:

1. Press and hold both buttons on the Display Module until the Display flashes a pattern. The Display will read “u- F” or “u- n” as shown in Figures 3.1.2-1 and 3.1.2-2 below.



Figure 3.1.2-1: Units – lbf.ft



Figure 3.1.2-2: Units - Nm

2. The units can be changed by pressing the Up or Down button to toggle between “F” (lbf.ft) and “n” (Nm) units as desired.

To exit the Unit Select menu:

1. Press and hold both buttons on the Module until the Display flashes, then release the buttons.
2. The LED Display will light a small LED dot in the bottom left corner of the display when Nm units are used (Figure 3.1.2-3), and will not light the dot when lbf.ft units are used (Figure 3.1.2-4).



Figure 3.1.2-3: Nm Display



Figure 3.1.2-4: lbf.ft Display

3.2 – Lock Mode

The BC-RAD Select Tool System has a built-in Lock function to prevent the user from changing pre-set torque values or changing torque units. The set torque value will remain saved on the LED Display even if the BC-RAD Select Battery is removed.

The BC-RAD Select requires a combination code to enter or exit Lock Mode. Contact W. Christie (Industrial) LTD. See Section 7.0 for contact information.

When the BC-RAD Select Tool System is in Lock Mode, the torque value cannot be changed using the Up or Down buttons. The BC-RAD Select must be first unlocked, the torque setting changed to the desired value, then locked again to prevent the torque setting from being changed.

When the BC-RAD Select is put into Lock Mode, the LED Display will scroll the word “Lock” until the buttons are released. In Lock Mode, the LED Display will light 2 small dots in the bottom left-hand side of the display. When the BC-RAD Select is unlocked, the LED Display will scroll the word “unlock” until the buttons are released.

4.0 – CALIBRATION

Calibration should only be carried out by W. Christie (Industrial) LTD.

5.0 – GENERAL OPERATING INSTRUCTIONS

WARNING Only qualified personnel with training in the safe operation of torque tooling and the BC-RAD Select Tool System should operate this tool. Refer to the Important Safety Notice for more information.

The BC-RAD Select operates in Torque Cycles. The Torque Cycle passes when the Actual Torque reaches the Target Torque, and the Cycle fails if it is interrupted before the Actual Torque reaches the Target Torque.

This section instructs the operator in the use of the Reaction Arm needed for BC-RAD Select operation and how to conduct a Torque Cycle.

5.1 – Reaction Arm

WARNING Always keep body parts clear of the Reaction Arm when the BC-RAD Select Tool System is in use. Serious injury could occur.

CAUTION Ensure the Reaction Arm has a solid contact point before operating the BC-RAD Select Tool System.

5.1.1 – Installing the Reaction Arm

Ensure the Reaction Arm and Snap Ring are installed securely to hold the Reaction Arm in place. Make sure the Reaction Arm is in contact with a solid Reaction Point before you operate the tool. Keep your body parts clear of the Reaction Arm when the tool is in operation.

When the tool is in operation the Reaction Arm rotates in the opposite direction to the Output Square Drive and must be allowed to rest squarely against a solid object or surface adjacent to the bolt to be tightened (Figure 5.1.1-1).

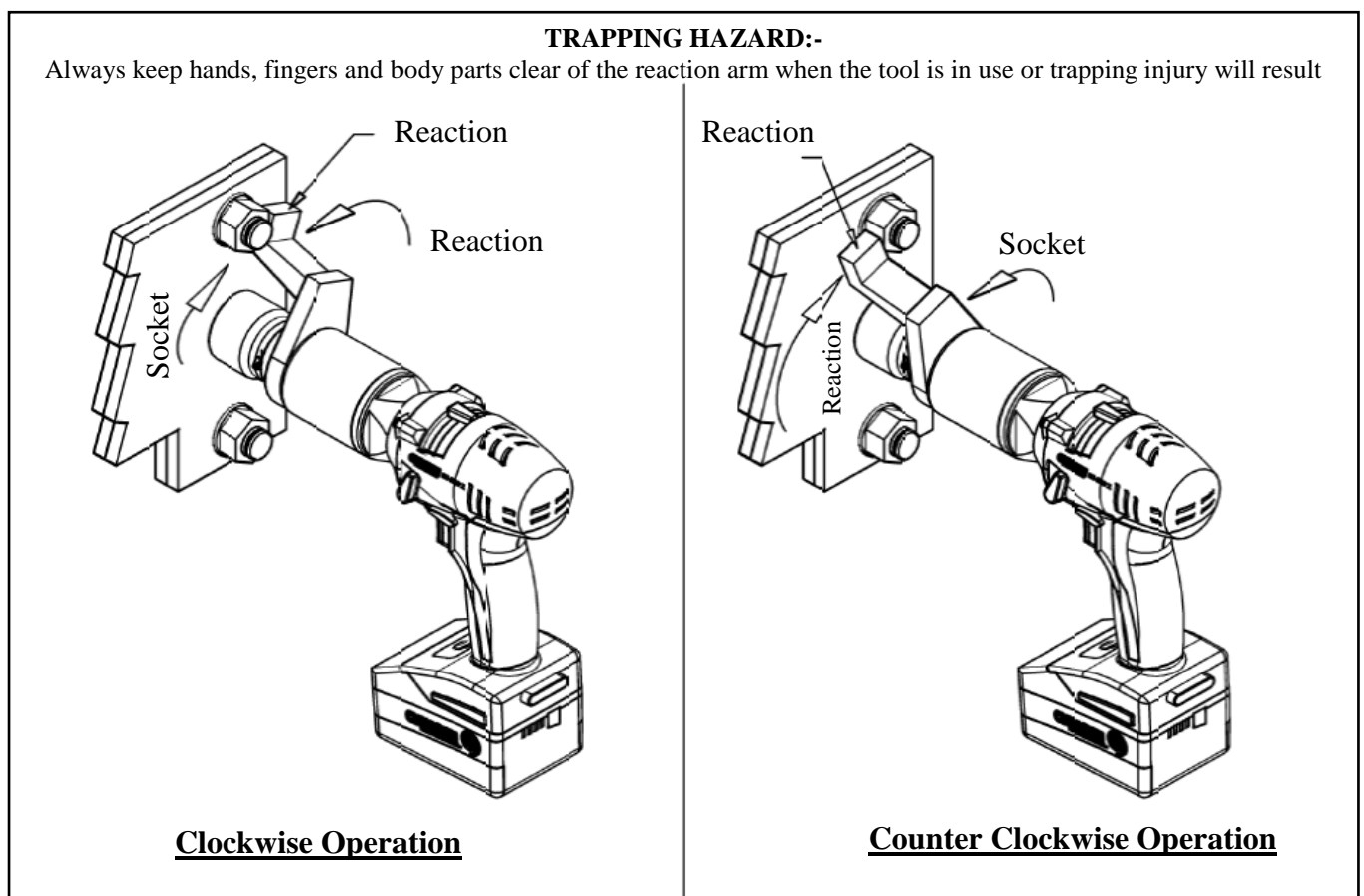

Figure 5.1.1-1 – Reaction Arm Rotation

CAUTION Keep your hand and body parts clear of the Reaction Arm and barrel when the tool is in operation.

5.1.2 – Reaction Arm Height

Ensure the height of the socket is even with the height of the Reaction Arm as seen below in Figure 5.1.2-1. The height of the socket cannot be shorter or higher than the height of the Reaction Arm as seen below in Figure 5.1.2-2.

CORRECT: The Reaction Arm and socket are even height

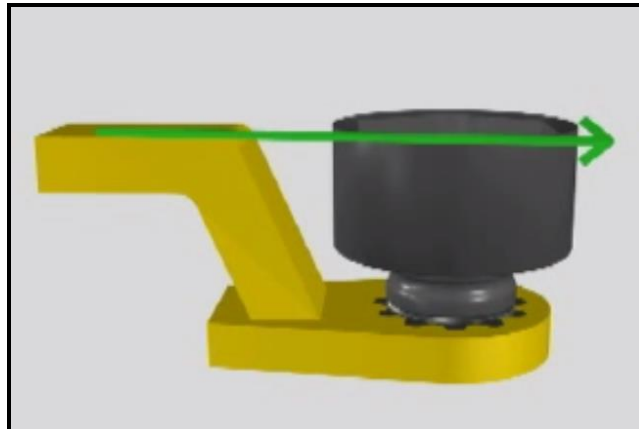

Figure 5.1.2-1: Correct Height

INCORRECT: The leg of the Reaction Arm is too short on the left side, and too long on the right side.

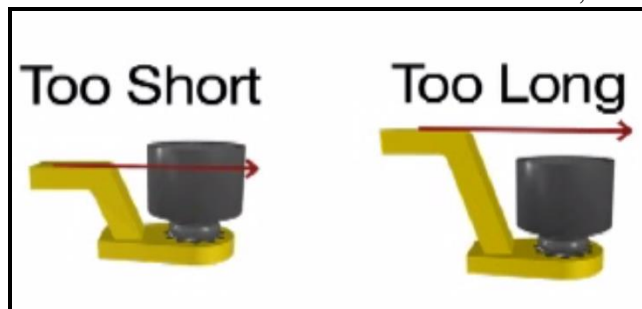

Figure 5.1.2-2: Incorrect Height

IMPROPER REACTION WILL VOID WARRANTY AND CAN CAUSE PREMATURE TOOL FAILURE.

5.1.3 – Reaction Arm Foot

Ensure the foot of the Reaction Arm aligns with the length of the nut as seen in Figure 5.1.3-1. The length of the foot cannot be shorter or longer than the nut as seen in Figure 5.1.3-2.

CORRECT: The foot of the Reaction Arm aligns with the length of the nut.

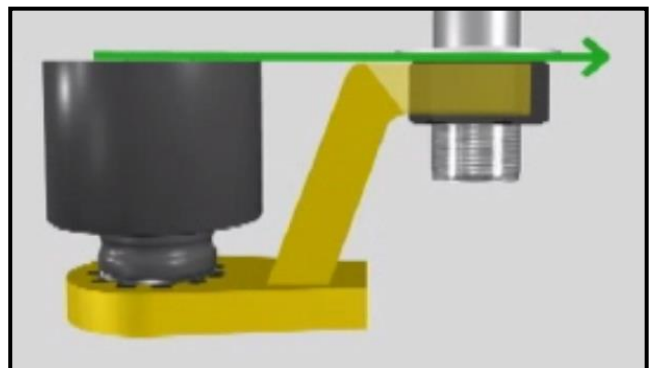

Figure 5.1.3-1: Correct Length

INCORRECT: The foot of the Reaction Arm is too short on the left side, and too long on the right side.

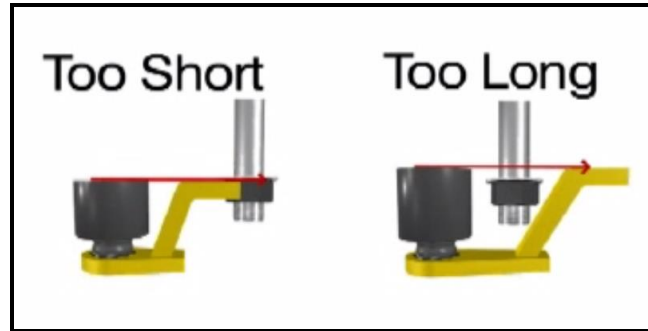

Figure 5.1.3-2: Incorrect Length

Please contact W. Christie (Industrial) LTD for custom Reaction Arms.

5.1.4 – Reaction Points

Ensure the Reaction Arm reacts off the middle of the foot as seen in Figure 5.1.4-1. Do not react off the heel of the reaction foot as seen in Figure 5.1.4-2.

CORRECT: Reaction Arm is reacting off the middle of the Reaction Arm's foot.



Figure 5.1.4-1: Correct Reaction Point

INCORRECT: Reaction Arm is reacting off the heel of the Reaction Arm. This can cause premature tool failure.

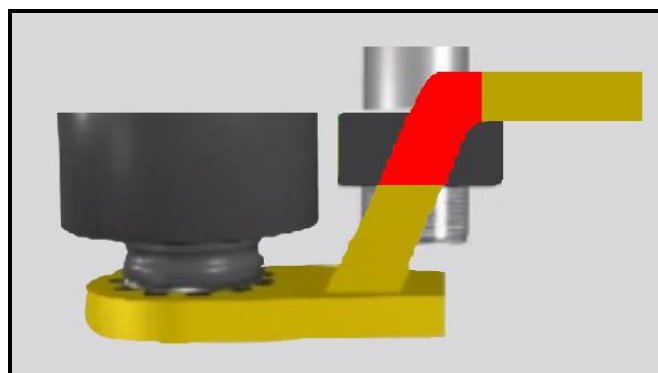

Figure 5.1.4-2: Incorrect Reaction Point

5.2 Torque Operation

To operate the tool in a Torque Cycle:

1. Ensure the tool is in Torque Select mode (Figure 5.2-1. Also see Section 3.1 – Torque Select Mode).



Figure 5.2-1: Torque Select Mode

2. Ensure the LED Display is showing the correct units (see Section 3.1.2 – Unit Select Menu).
3. Increment or decrement the displayed torque until the desired torque is displayed.

Note: The Display will increment or decrement by 10 units with a single button push, or by 100 units if a button is held down. See Section 3.1.1 – Setting Torque for more information.

4. The BC-RAD Select Tool System will immediately be ready to torque at the displayed setting. Place the BC-RAD Select on the joint system.
5. Ensure the Forward/Reverse Switch is in the Forward position.
6. Press and hold the On/Off Trigger.

Note: To stop the Torque Cycle at any time, release the On/Off Trigger.

7. When the BC-RAD Select reaches the selected Torque, the tool will stop turning. Release the On/Off Trigger.

6.0 - TROUBLESHOOTING

IMPORTANT Disassembling or attempting repair will void warranty.

If breakdown, malfunction, or error occurs, contact W. Christie (Industrial) LTD Support (refer to Section 7.0 – Contact Us).

The LED Display may exhibit abnormal behaviour depending on operating conditions, frequency of use, or excessive wear on the Display Module.

The Display Module is designed to withstand normal use over the lifetime of the BC-RAD Select Tool System; however, as a sensitive electronic device it is susceptible to damage caused by shock, moisture, or excessive force.



E.C. DECLARATION OF CONFORMITY

MODELS COVERED: BC-RAD 3X Select, BC-RAD 7X Select, BC-RAD 7XA Select, BC-RAD14X Select, BC-RAD 14XA Select, BC-RAD 20X Select, BC-RAD 20XA Select, BC-RAD 40X Select, BC-RAD 40XA Select

DESCRIPTION: Digital Battery Torque Wrench

We hereby declare that the following machinery complies with the essential health and safety requirements of the European Machinery Directive 2006/42/EC published on the 9th June 2006

W Christie (Industrial) Ltd, Meadowbank Road, Rotherham S61 2NF, United Kingdom.

This machinery has been designed and manufactured in accordance with the following transposed harmonised European Standard:-

BS EN ISO 12100-2:2003 Safety of Machinery – Technical Principles

BS EN 60745-1:2006 Hand-held Motor Operated Electric Tools – Safety – General Requirements

SIGNED: 

POSITION: Senior Applications Engineer

NAME: R. G. Askham

On behalf of W Christie (Industrial) Ltd

7.0 CONTACT US



W. CHRISTIE (INDUSTRIAL) LTD
Christie House, Meadowbank Road,
Rotherham, South Yorkshire, S61 2NF

t: +44(0)1709 550088

e: info@wchristie.com

f: +44(0)1709 550030

w: www.wchristie.com



CHRISTIE
TOTAL TORQUE SOLUTIONS