

# GH2T

## GANTRY SERIES



# SUMNER

Sumner Manufacturing Co., Inc.

## All New 2-Ton Aluminum Gantry



- ✓ Available in 8', 10', 12' & 15' or 3 m, 4 m & 5 m beam lengths
- ✓ 2 Metric Ton (4,400 lb) Capacity
- ✓ Lightweight & Extremely Portable
- ✓ Quick Two-Person Assembly
- ✓ Adjustable Span
- ✓ Minimum Pieces – 2 A-Frames with 8" casters, Trolley, Cross Beam and attaching hardware
- ✓ Aluminum Frames & Beam
- ✓ Anodized frame
- ✓ 8" Locking Casters
- ✓ Quick Height Adjustment
- ✓ Pinch Point Free

### Innovative Mast Height Adjustment

1



Adjust mast lifting handle with plunger pin to comfortable lifting position



8' (2.4 m) Beam  
Chain hoist not included

2



Lift mast and remove quick-action mast locking pin – no bolts!

3



When lifting handle is next to frame, mast holes are aligned for locking pin

Adjust height in 6" (15 cm) increments

# GH-2T UNIQUE FEATURES

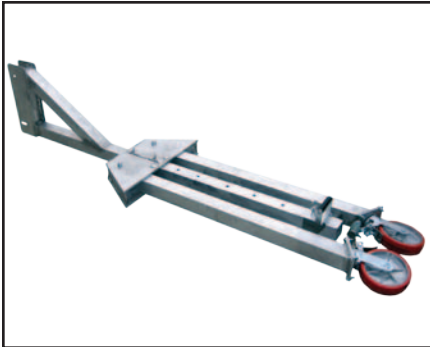

A-frame legs lock in closed position – no bolts

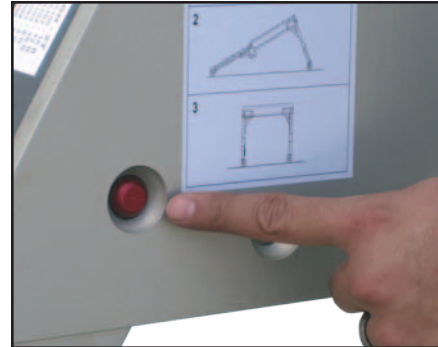

Push button leg lock release & locking



A-Frame legs lock in closed or opened position



No pinch points – spacer prevents pinched fingers

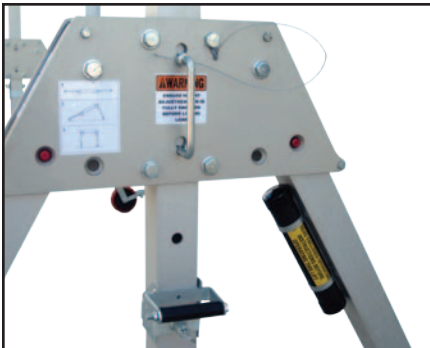

Tool-free A-Frame operation ... with instructions tube



Casters can be locked at 90 degree angle for easy transport



8" caster with foot brake & four 90 degree locking positions



Beam span adjustment on 10 ft (3 m) lengths & longer

# GANTRY ASSEMBLY

The Sumner GH2T Gantry can be assembled in minutes with just two people and two wrenches. The leverage design eliminates the need for fork lifts or other lifting devices. The all aluminum frame resists corrosion and is light weight.



**1** Open "A" frame

**2** Lay out beam & "A" frames

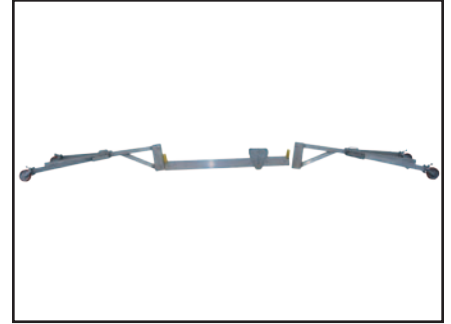

**3** Attach with one bolt to each "A" frame

**4** Ready to lift

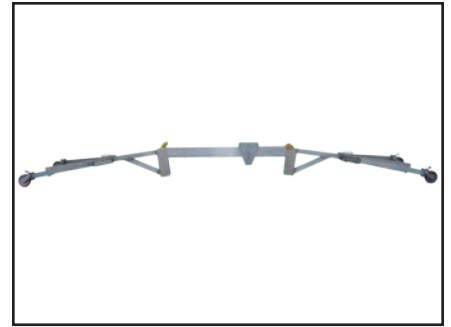

**5** Raise one frame

**6** Raised frame



**7** Raise 2nd "A" frame

**8** Attach 2nd bolts & tighten all



# GH2T Gantry Lift Dimensions

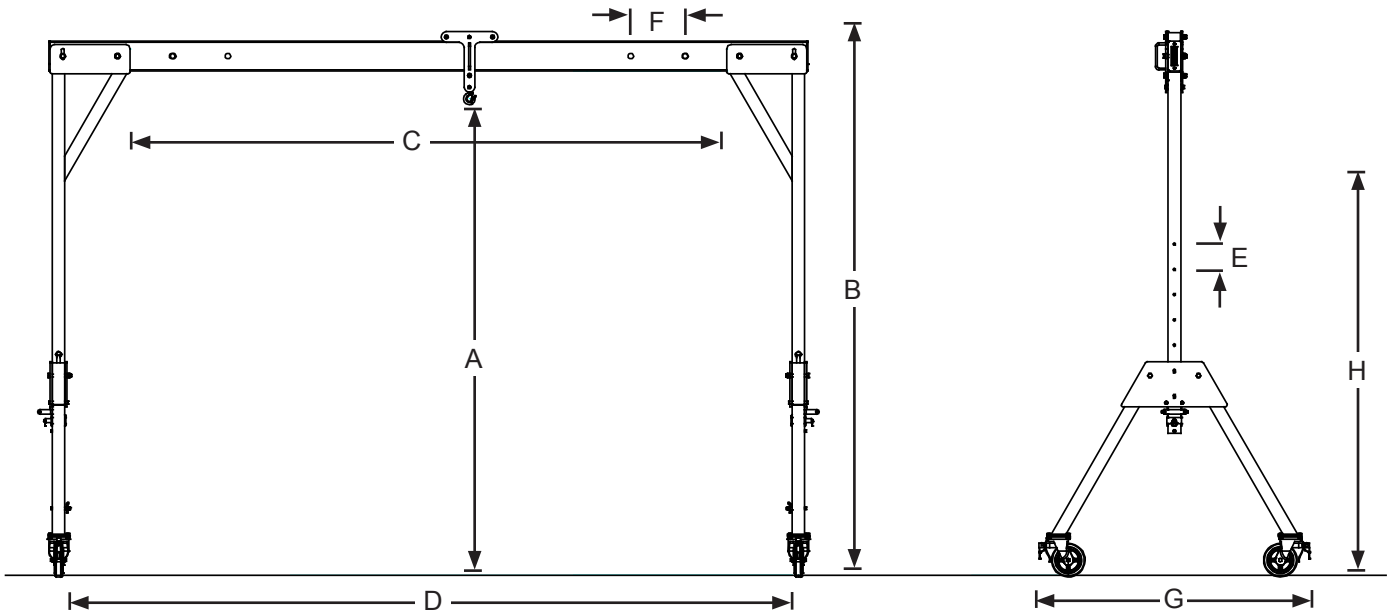

Part No.	Gantry Model	A Max/Min Height To Lifting Eye	B Max Height To Top Of Trolley	C Max Working Span	D Span Between Wheels	E Height Adjustment	F Span Adjustment*	G Max Width Of "A" Frame	H Stored Height of "A" Frame
785100	GH2T-15 (15' Beam)	114"	128.5" (326.39 cm)	142" (360.68 cm)	15' 1" (459.74 cm)	6" (15.24 cm)	13" (33.02 cm)	60.625" (153.98 cm)	100" (254 cm)
785101	GH2T-12 (12' Beam)	(289.56 cm)		106" (269.24 cm)	12' (365.76 cm)				
785102	GH2T-10 (10' Beam)	84"	128.5" (326.39 cm)	82" (208.28 cm)	10' (304.8 cm)	6" (15.24 cm)	13" (33.02 cm)	60.625" (153.98 cm)	100" (254 cm)
785103	GH2T-8 (8' Beam)	(213.36 cm)		58" (147.32 cm)	8' (243.84 cm)				

GH2T Gantry comes with 2 A-Frames with 8" casters, Trolley, Cross Beam and attaching hardware.

\*15" beam has 3 adjustment positions.  
8" beam has none.

Gantry Part No.	Gantry Model	Weight		Beam Part No.	Beam Model	Weight	
		lbs	kg			lbs	kg
785100	GH2T-15 (15' Beam)	323.0	146.5	785150	15'	82.0	37.1
785101	GH2T-12 (12' Beam)	307.0	139.2	785151	12'	65.6	29.7
785102	GH2T-10 (10' Beam)	296.0	134.2	785152	10'	54.7	24.8
785103	GH2T-8 (8' Beam)	285.0	129.2	785153	8'	47.7	21.6

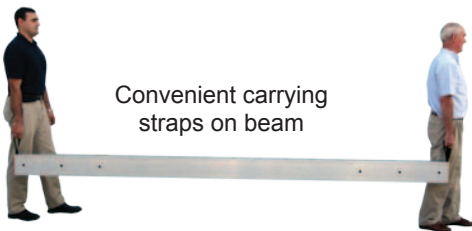

**SUMNER**  
Sumner Manufacturing Co., Inc.  
www.sumner.com

**Sumner - U.S.**  
7514 Alabonson Road  
Houston, TX 77088  
Ph: 281-999-6900  
Fax: 281-999-6966

**Sumner Canada**  
75 Saltsman Drive, Unit 5  
Cambridge, Ontario N3H 4R7  
Ph: 519-653-5300  
Fax: 519-653-5305

**Sumner U.K.**  
Unit 3 Kempton Road  
Keytec 7 Business Park  
Pershore, Worcestershire, WR10 2TA  
Ph: (44) 01386 556278  
Fax: (44) 01386 556776

**Sumner Netherlands**  
Midden Engweg 21  
NL-3882TS Putten  
Ph: (31) 0 85 489 0284

**DISTRIBUTED BY:**