

INSTRUCTION MANUAL

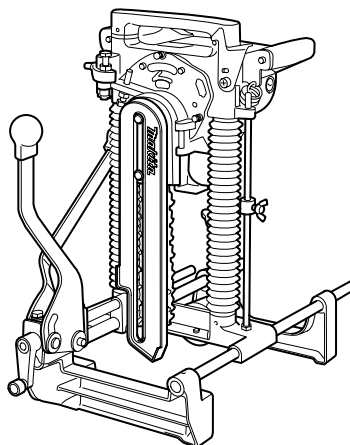

Chain Mortiser

7104L



006289

IMPORTANT: Read Before Using.

ENGLISH (Original instructions)

SPECIFICATIONS

Model		7104L
Capacities	Max. hole length (Longitudinal)	130 mm
	Max. hole depth	155 mm
Width of applicable workpiece		80 mm - 308 mm
Chain speed		300 m / min
Dimensions (L × W × H)		512 mm × 298 mm × 513 mm
Net weight		17.3 kg
Safety class		Class I

- Due to our continuing programme of research and development, the specifications herein are subject to change without notice.
- Specifications may differ from country to country.
- Weight according to EPTA-Procedure 01/2003

END224-1

ENG905-1

Symbols

The following show the symbols used for the equipment. Be sure that you understand their meaning before use.



- Read instruction manual.



- Only for EU countries
Do not dispose of electric equipment together with household waste material! In observance of European Directive 2002/96/EC on waste electric and electronic equipment and its implementation in accordance with national law, electric equipment that have reached the end of their life must be collected separately and returned to an environmentally compatible recycling facility.

ENE062-1

Intended use

The tool is intended for cutting mortise in wood.

ENF001-1

Power supply

The tool should be connected only to a power supply of the same voltage as indicated on the nameplate, and can only be operated on single-phase AC supply. This tool should be grounded while in use to protect the operator from electric shock. Use only three-wire extension cords which have three-prong grounding-type plugs and three-pole receptacles which accept the tool's plug.

Noise

The typical A-weighted noise level determined according to EN61029:

- Sound pressure level (L_{pA}) : 90 dB(A)
- Sound power level (L_{WA}) : 103 dB(A)
- Uncertainty (K) : 3 dB(A)

Wear ear protection

ENG900-1

Vibration

The vibration total value (tri-axial vector sum) determined according to EN61029:

- Vibration emission (a_n) : 2.5 m/s² or less
- Uncertainty (K) : 1.5 m/s²

ENG901-1

- The declared vibration emission value has been measured in accordance with the standard test method and may be used for comparing one tool with another.
- The declared vibration emission value may also be used in a preliminary assessment of exposure.

⚠WARNING:

- The vibration emission during actual use of the power tool can differ from the declared emission value depending on the ways in which the tool is used.
- Be sure to identify safety measures to protect the operator that are based on an estimation of exposure in the actual conditions of use (taking account of all parts of the operating cycle such as the times when the tool is switched off and when it is running idle in addition to the trigger time).

For European countries only

EC Declaration of Conformity

We Makita Corporation as the responsible manufacturer declare that the following Makita machine(s):

Designation of Machine:

Chain Mortiser

Model No./ Type: 7104L

are of series production and

Conforms to the following European Directives:

2006/42/EC

And are manufactured in accordance with the following standards or standardised documents:

EN61029

The technical documentation is kept by our authorised representative in Europe who is:

Makita International Europe Ltd.

Michigan Drive, Tongwell,

Milton Keynes, Bucks MK15 8JD, England

30.1.2009



Tomoyasu Kato

Director

Makita Corporation

3-11-8, Sumiyoshi-cho,

Anjo, Aichi, 446-8502, JAPAN

000230

GEA005-3

General Power Tool Safety Warnings

⚠ WARNING Read all safety warnings and all instructions. Failure to follow the warnings and instructions may result in electric shock, fire and/or serious injury.

Save all warnings and instructions for future reference.

The term "power tool" in the warnings refers to your mains-operated (corded) power tool or battery-operated (cordless) power tool.

Work area safety

- Keep work area clean and well lit.** Cluttered or dark areas invite accidents.
- Do not operate power tools in explosive atmospheres, such as in the presence of flammable liquids, gases or dust.** Power tools create sparks which may ignite the dust or fumes.
- Keep children and bystanders away while operating a power tool.** Distractions can cause

you to lose control.

Electrical safety

- Power tool plugs must match the outlet. Never modify the plug in any way. Do not use any adapter plugs with earthed (grounded) power tools.** Unmodified plugs and matching outlets will reduce risk of electric shock.
- Avoid body contact with earthed or grounded surfaces such as pipes, radiators, ranges and refrigerators.** There is an increased risk of electric shock if your body is earthed or grounded.
- Do not expose power tools to rain or wet conditions.** Water entering a power tool will increase the risk of electric shock.
- Do not abuse the cord. Never use the cord for carrying, pulling or unplugging the power tool. Keep cord away from heat, oil, sharp edges or moving parts.** Damaged or entangled cords increase the risk of electric shock.
- When operating a power tool outdoors, use an extension cord suitable for outdoor use.** Use of a cord suitable for outdoor use reduces the risk of electric shock.
- If operating a power tool in a damp location is unavoidable, use a residual current device (RCD) protected supply.** Use of an RCD reduces the risk of electric shock.
- Use of power supply via a RCD with a rated residual current of 30mA or less is always recommended.**

Personal safety

- Stay alert, watch what you are doing and use common sense when operating a power tool. Do not use a power tool while you are tired or under the influence of drugs, alcohol or medication.** A moment of inattention while operating power tools may result in serious personal injury.
- Use personal protective equipment. Always wear eye protection.** Protective equipment such as dust mask, non-skid safety shoes, hard hat, or hearing protection used for appropriate conditions will reduce personal injuries.
- Prevent unintentional starting. Ensure the switch is in the off-position before connecting to power source and/or battery pack, picking up or carrying the tool.** Carrying power tools with your finger on the switch or energising power tools that have the switch on invites accidents.
- Remove any adjusting key or wrench before turning the power tool on.** A wrench or a key left attached to a rotating part of the power tool may result in personal injury.
- Do not overreach. Keep proper footing and balance at all times.** This enables better control

of the power tool in unexpected situations.

16. **Dress properly. Do not wear loose clothing or jewellery. Keep your hair, clothing, and gloves away from moving parts.** Loose clothes, jewellery or long hair can be caught in moving parts.
17. **If devices are provided for the connection of dust extraction and collection facilities, ensure these are connected and properly used.** Use of dust collection can reduce dust-related hazards.

Power tool use and care

18. **Do not force the power tool. Use the correct power tool for your application.** The correct power tool will do the job better and safer at the rate for which it was designed.
19. **Do not use the power tool if the switch does not turn it on and off.** Any power tool that cannot be controlled with the switch is dangerous and must be repaired.
20. **Disconnect the plug from the power source and/or the battery pack from the power tool before making any adjustments, changing accessories, or storing power tools.** Such preventive safety measures reduce the risk of starting the power tool accidentally.
21. **Store idle power tools out of the reach of children and do not allow persons unfamiliar with the power tool or these instructions to operate the power tool.** Power tools are dangerous in the hands of untrained users.
22. **Maintain power tools. Check for misalignment or binding of moving parts, breakage of parts and any other condition that may affect the power tool's operation. If damaged, have the power tool repaired before use.** Many accidents are caused by poorly maintained power tools.
23. **Keep cutting tools sharp and clean.** Properly maintained cutting tools with sharp cutting edges are less likely to bind and are easier to control.
24. **Use the power tool, accessories and tool bits etc. in accordance with these instructions, taking into account the working conditions and the work to be performed.** Use of the power tool for operations different from those intended could result in a hazardous situation.

Service

25. **Have your power tool serviced by a qualified repair person using only identical replacement parts.** This will ensure that the safety of the power tool is maintained.
26. **Follow instruction for lubricating and changing accessories.**
27. **Keep handles dry, clean and free from oil and grease.**

ADDITIONAL SAFETY RULES

1. **Use this tool only to cut holes in wood.**
2. **This tool is for cutting holes in flat-surfaced wood. Never use it for cutting holes in a log.**
3. **Wear ear protectors.**
4. **Handle the cutter chain carefully; it is very sharp.**
5. **Place the workpiece on wood blocks or short beams to prevent the cutter chain from hitting the ground, floor, etc., causing damage to the cutter chain at the time of hole breakthrough.**
6. **Check the cutter chain carefully for cracks or damage before operation.** Replace cracked or damaged cutter chain immediately.
7. **Secure the tool to the workpiece firmly.**
8. **Inspect for and remove nails or foreign matter from the workpiece before operation.**
9. **Do not operate the tool with the safety cover open.**
10. **Do not wear gloves during operation.**
11. **Keep hands away from moving parts.**
12. **Remove the tool from the workpiece after operation to keep it from falling off and possibly causing injury.**
13. **Do not abuse cord. Never yank cord to disconnect it from the receptacle. Keep cord away from heat, oil, water and sharp edges.**
14. **PROPER GROUNDING.** This tool should be grounding while in use to protect the operator from electric shock.
15. **EXTENSION CORDS.** Use only three-wire extension cords which have three-prong grounding-type plugs and three-pole receptacles which accept the tool's plug. Replace or repair damaged or worn cord immediately.

SAVE THESE INSTRUCTIONS.

FUNCTIONAL DESCRIPTION

⚠ CAUTION:

- Always be sure that the tool is switched off and unplugged before adjusting or checking function on the tool.

Adjusting depth of cut

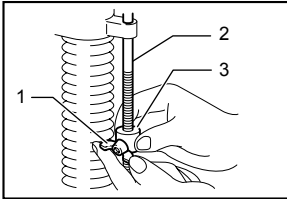

005999

Loosen the wing bolt on the stopper. Move the stopper to the desired position and tighten the wing bolt. When tightened, the tip of the wing bolts should contact the flat surface of the stopper pole. The numbers indicated on the stopper pole are in cm units (3 mm per graduation).

1. Wing bolt
2. Stopper pole
3. Stopper

Switch action

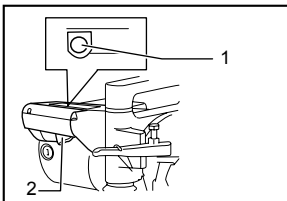

006300

⚠ CAUTION:

- Before plugging in the tool, always check to see that the switch trigger actuates properly and returns to the "OFF" position when released.

To prevent the switch trigger from being accidentally pulled, a lock-off button is provided. To start the tool, push in the lock-off button and pull the switch trigger. Release the switch trigger to stop.

ASSEMBLY

⚠ CAUTION:

- Always be sure that the tool is switched off and unplugged before carrying out any work on the tool.

Installing or removing cutter chain

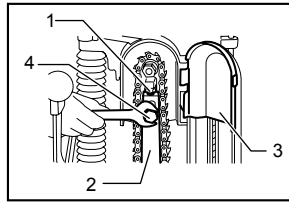

006290

⚠ WARNING:

- Always be sure that the tool is switched off and unplugged before installing or removing the cutter chain.
- Always close the chain cover after installing, removing or adjusting the cutter chain.

To install the cutter chain, open the chain cover. Loosen the hex bolt securing the chain bar and the adjusting screw.

Orient the cutters in the direction of the arrow on the tool (rotational direction). Attach the cutter chain to the sprocket first and then to the chain bar. Semi-tighten the hex bolt.

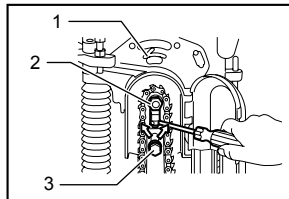

006291

Turn the adjusting screw to increase the tension on the cutter chain. Pull the middle of the cutter chain lightly. When there is a clearance of approx. 5 - 6 mm between the chain bar and the cutter chain, the tension on the cutter chain is adequate.

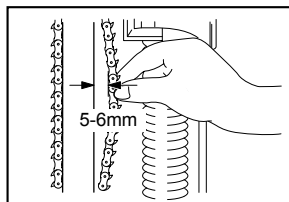

006003

After adjusting the tension, tighten the hex bolt firmly to secure the chain bar. Additionally tighten slightly the adjusting screw. Close the chain cover.

To remove the cutter chain, follow the installation procedures in reverse.

Securing tool to workpiece

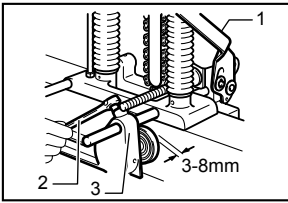

1. Lever (A)
2. Vise lever
3. Rear vise

006004

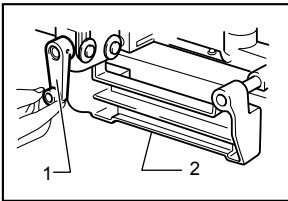

1. Setting handle
2. Front vise

006005

Loosen the vise lever and move the rear vise backward. Place the tool on the workpiece so that the front vise contacts the side of the workpiece. Move the rear vise forward until the distance between the rear vise and the workpiece is 3 - 8 mm. Tighten the vise lever to secure the rear vise. Move the tool so that the "0" on the indication plate is aligned with the cutting line (A). Push the lever (A) down fully to secure the workpiece. Turn the setting handle until the front edge of the yellow indicator plate is aligned with the cutting line (B).

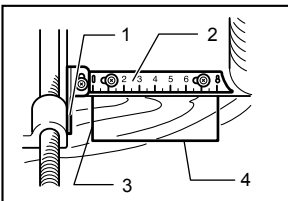

1. Indicator plate
2. Indication plate
3. Cutting line (A)
4. Cutting line (B)

006006

OPERATION

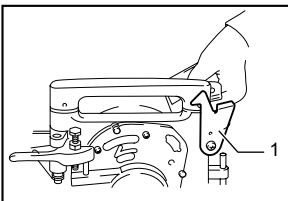

1. Hook

006007

Grasp firmly the grips on either side. Switch on the tool and wait until the cutter chain attains full speed. Then

release the hook and lower the tool head to cut in the workpiece. Do not apply excessive pressure to the tool. This may not only decrease the working efficiency but also cause a dangerous reaction. Feed slowly at the beginning of a cutting operation, at the time of hole breakthrough and when cutting a knot in the workpiece. After cutting, gently raise the tool head until you can hook the tool head back onto the hook. Then switch off the tool. Raise the lever (A) and remove the tool from the workpiece.

⚠WARNING:

- Always hook the tool head back onto the hook when not operating the tool.
- Never attempt to cut a twisted or warped workpiece which the tool is not secured firmly to.

Adjusting indicator plate and indication plate

The yellow indicator plate and indication plate are factory adjusted for the standard equipped cutter chain 16.5 mm. If the alignment is off, for some reason, or when using another size cutter chain, loosen the screws and adjust the yellow indicator plate and indication plate.

Enlarging hole

1. Transverse (width) enlargement

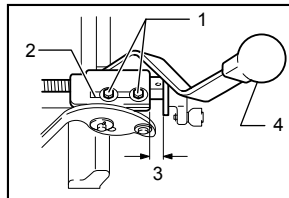

1. Hex bolts
2. Gauge plate
3. Travel distance (D)
4. Lever (B)

006008

A hole can be enlarged transversely by adjusting the gauge plate. Max. expansion of hole width is 15 mm.

Example:

When cutting a hole 25 mm wide using a cutter chain 16.5 mm, proceed as follows:

- Push the lever (B) away from you. Loosen the hex bolts securing the gauge plate.
- Adjust the gauge plate so that the travel distance (D) is 8.5 mm; that is, $25 \text{ mm} - 16.5 \text{ mm} = 8.5 \text{ mm}$. Tighten the hex bolts to secure the gauge plate.
- Cut the first hole with the lever (B) pushed away from you. Then pull the lever (B) toward you and cut again to enlarge the hole.

NOTE:

- The gauge plate is factory adjusted for cutting a hole 30 mm wide.

2. Longitudinal (length) enlargement

Hole length can be determined in three steps shown in the table below.

Cutter chain position	Hole length to be cut
Original position	52.5 mm
No.1 set position	52.5 mm - 105 mm
No.2 set position	77.5 mm - 130 mm

006562

NOTE:

- A hole a little longer than predetermined may be cut depending upon the cutter chain tension.
- The adjusting hex bolts are factory adjusted for cutting holes 90 mm long in the No.1 set position and 120 mm long in the No.2 set position.

Push down the right-hand grip while raising the left-hand grip. Make sure that the adjusting hex bolt slips into place securely.

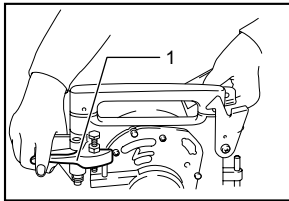

1. Lever (C)

006009

Loosen the hex nut securing the adjusting hex bolt. Turn the adjusting hex bolt until the cutter chain reaches the desired position, then tighten the hex nut.

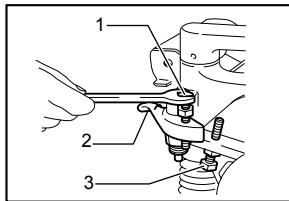

1. Adjusting hex bolt for No. 1 set position
 2. Lever (C)
 3. Adjusting hex bolt for No. 2 set position

006010

⚠WARNING:

- When using pressure to turn the adjusting hex bolt or hex nut, be careful not to allow the adjusting hex bolt to slip off the set position.

To bring the cutter chain back to the perpendicular (original) position, pull the lever (C) toward you while pressing down on the right-hand grip and slightly raising the left-hand grip and move the cutter chain back to its original position.

When cutting a hole, first use the perpendicular position, then No.1 set position and finally No.2 set position. Always safely hook the tool head back onto the hook when changing the cutter chain position.

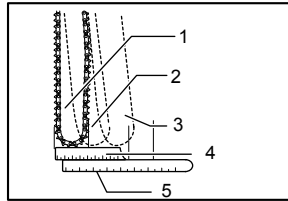

1. Original position
 2. No.1 set position
 3. No.2 set position
 4. Indication plate
 5. Ruler

006011

When enlarging a hole both transversely and longitudinally, cut the holes in the order indicated from No.(1) to (6) as shown. This makes for more easy and efficient hole enlargement.

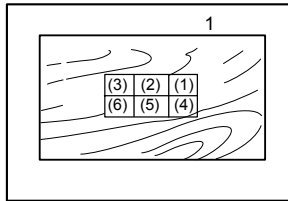

1. Front base

006012

⚠WARNING:

- Never attempt to enlarge a hole with the cutter chain still within the hole. This will cause unstable and dangerous operation.
- Never angle the cutter chain when cutting the first hole, or a dangerous kickback may result. Always have the cutter chain set to the perpendicular position when cutting the first hole.

Lap joints up to 130 mm can be cut with this tool.

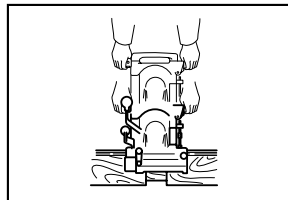

006013

NOTE:

- Lap joints can be cut only on the front (side away from you) of the workpiece.

MAINTENANCE

CAUTION:

- Always be sure that the tool is switched off and unplugged before attempting to perform inspection or maintenance.
- Never use gasoline, benzine, thinner, alcohol or the like. Discoloration, deformation or cracks may result.

Replacing carbon brushes

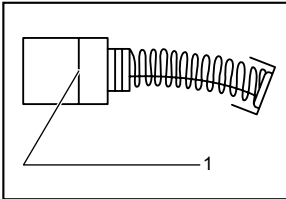

1. Limit mark

001145

Remove and check the carbon brushes regularly. Replace when they wear down to the limit mark. Keep the carbon brushes clean and free to slip in the holders. Both carbon brushes should be replaced at the same time. Use only identical carbon brushes. Use a screwdriver to remove the brush holder caps. Take out the worn carbon brushes, insert the new ones and secure the brush holder caps.

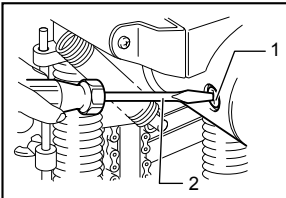

1. Brush holder cap
2. Screwdriver

006014

Lubrication

After use, remove dirt, chips and foreign matter adhering to the tool. Then oil the moving parts (especially cutter chain) and the contact portions.

To maintain product SAFETY and RELIABILITY, repairs, any other maintenance or adjustment should be performed by Makita Authorized Service Centers, always using Makita replacement parts.

ACCESSORIES

CAUTION:

- These accessories or attachments are recommended for use with your Makita tool specified in this manual. The use of any other accessories or attachments might present a risk of injury to persons. Only use accessory or attachment for its stated purpose.

If you need any assistance for more details regarding these accessories, ask your local Makita Service Center.

- Cutter chain
- Chain bar for 30 mm
- Sprocket 4 for 30 mm
- Oil supply (100 cc)

Makita Corporation
Anjo, Aichi, Japan

883685B221

www.makita.com